

# In-line Type Vacuum Ejector New

RoHS

## Compact and Lightweight

New female thread type

O.D.  $\varnothing$  **10.4** / (Current model  $\varnothing$  12.8)

Weight **3.9 g** / (Current model 6.5 g)

Overall length **52 mm** / (Current model 59 mm)

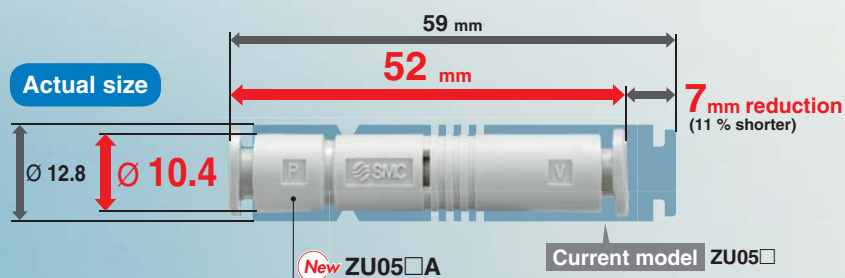

### Variations

Model	Nozzle size [mm]	Vacuum pressure reached* [kPa]		Maximum suction flow rate [l/min(ANR)]		Air consumption [l/min(ANR)]	Port size
		Type S	Type L	Type S	Type L		
ZU05□A	0.5	-90	-48	7	13	14	Ø 6 One-touch fitting Rc 1/8
ZU07□A	0.7			11	16	28	

\*1 Supply pressure: 0.45 MPa

## ZU□A Series



CAT.EUS100-118A-UK

# In-line Type Vacuum Ejector

## ZU□A Series

RoHS

### How to Order

ZU 05 S A □

Nozzle diameter

05	0.5 mm
07	0.7 mm

Port size

—	∅ 6 One-touch fitting
01	Rc 1/8 female thread

Vacuum pressure reached

S	-90 kPa
L	-48 kPa

Symbol

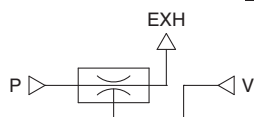

### Specifications

Operating temperature range	-5 to 50 °C (No freezing)
Fluid	Air
Applicable tubing material	FEP, PFA, Nylon, Soft nylon, Polyurethane
Operating pressure range	0.1 to 0.6 MPa
Standard supply pressure	0.45 MPa

### Ejector Specifications<sup>\*1</sup>

Model	Nozzle diameter [mm]	Vacuum pressure reached <sup>*2</sup> [kPa]		Maximum suction flow rate <sup>*2</sup> [l/min(ANR)]		Air consumption <sup>*2</sup> [l/min(ANR)]	Weight [g]	
		Type S	Type L	Type S	Type L		One-touch connection	Screw-in connection
ZU05□A	0.5	-90	-48	7	13	14	3.9	18.6
ZU07□A	0.7			11	16			

\*1 The values indicating characteristics are representative values, and may vary depending on the atmospheric pressure (weather, altitude, etc.).

\*2 Supply pressure: 0.45 MPa

### Construction

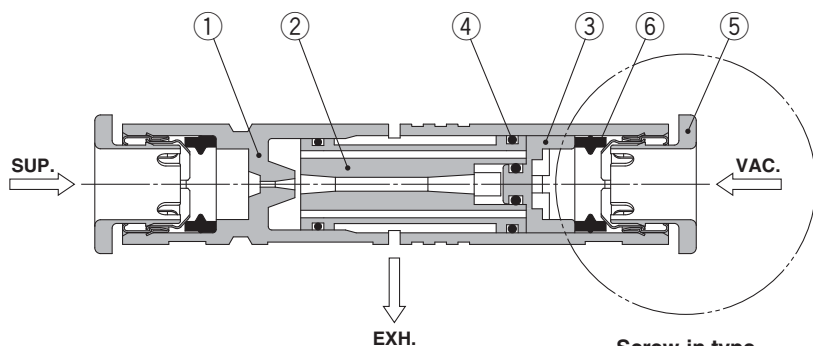

### Component Parts

No.	Description	Material	Note
1	Body	PBT	
2	Diffuser	PBT	Type S: White, Type L: Black
3	Cap	POM	
4	O-ring	NBR	Grease applied
5	Cassette	—	
6	Seal	NBR	Grease applied
7	Screw-in stud	Brass	Electroless nickel plating

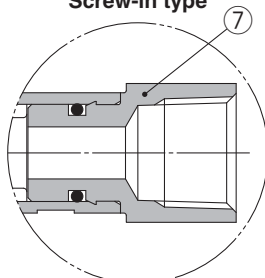

### ⚠ Precautions

Be sure to read this before handling the products. Refer to the back cover for safety instructions. For vacuum equipment precautions, refer to the “Handling Precautions for SMC Products” and the “Operation Manual” on the SMC website: <http://www.smc.eu>

### Mounting

#### ⚠ Caution

1. When the product is mounted in between piping, the piping on both the P port and V port should be adequately supported to avoid causing unnecessary loading and stressing of the product which may lead to performance issues or damage to the body of the product.

When mounting the product, please do not block the exhaust port at the centre of the body as this may cause performance issues.

### Piping

#### ⚠ Caution

##### 1. Piping diameter

The piping diameter for each port should be the standard size of One-touch fitting. If the piping diameter is reduced, it may lead to insufficient flow of supply air, reduction of suction flow and reduction in the vacuum pressure.

### Model Selection

#### ⚠ Caution

##### 1. Supply valve

Select the supply valve which can supply sufficient flow rate compared with the ejector air consumption. If the flow rate of the supply valve is insufficient, it may lead to vacuum failure. The selected supply valve should at least have the C factor shown in the table below.

#### Minimum C Factor of a Supply Valve

Model	C [dm <sup>3</sup> /(s·bar)]
ZU05	0.12
ZU07	0.23

### Air Supply

#### ⚠ Caution

##### 1. Quality of supply air

Use clean compressed air as fluid. (Air quality class 2 : 4 : 3, 2 : 5 : 3, or 2 : 6 : 3 as specified in ISO 8573-1: 2010 is recommended.)

If impurity enters the product, vacuum performance might be reduced due to deterioration of air passage and clogging of exhaust system.

## Exhaust Characteristics/Flow Rate Characteristics (Representative value)

(Flow rate characteristics: Supply pressure: 0.45 MPa)

### ZU05SA

**Exhaust Characteristics**

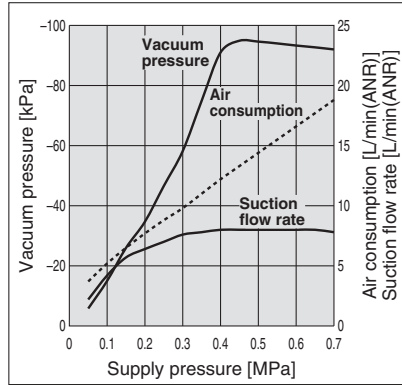

**Flow Rate Characteristics**

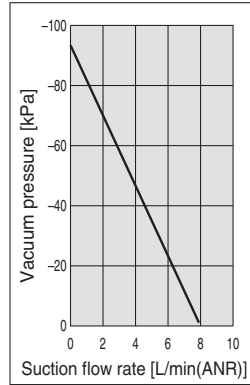

### ZU05LA

**Exhaust Characteristics**

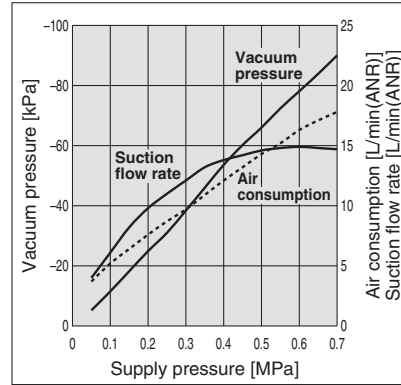

**Flow Rate Characteristics**

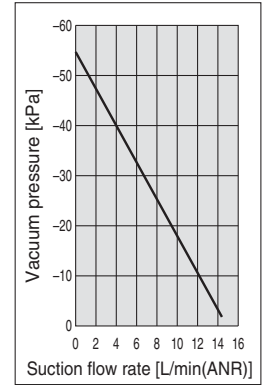

### ZU07SA

**Exhaust Characteristics**

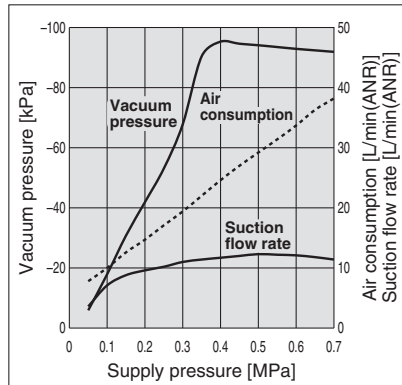

**Flow Rate Characteristics**

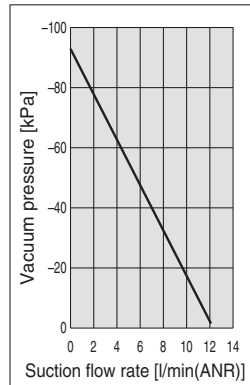

### ZU07LA

**Exhaust Characteristics**

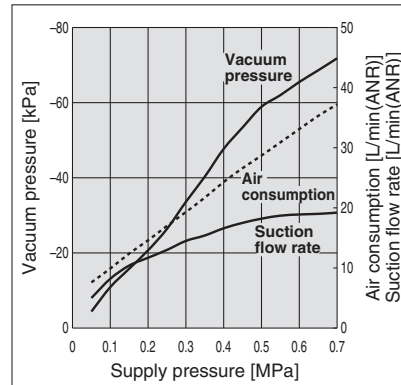

**Flow Rate Characteristics**

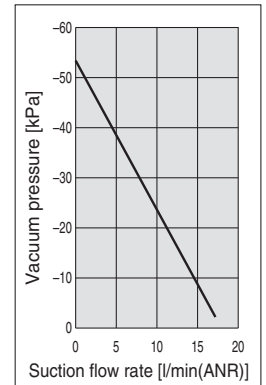

## Dimensions

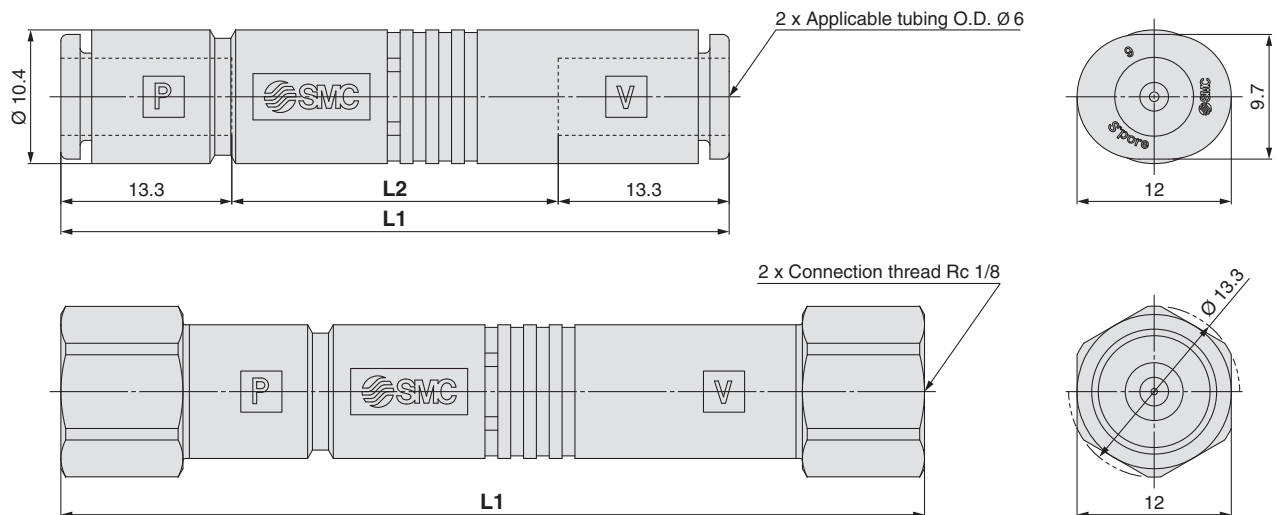

### One-touch Connection



Model	L1	L2
ZU05□A	52	25.4
ZU07□A	59	32.4

### Screw-in Connection

Model	L1
ZU05□A01	67.2
ZU07□A01	74.2

## Safety Instructions

These safety instructions are intended to prevent hazardous situations and/or equipment damage. These instructions indicate the level of potential hazard with the labels of “Caution,” “Warning” or “Danger.” They are all important notes for safety and must be followed in addition to International Standards (ISO/IEC)\*1), and other safety regulations.

-  **Caution:** Caution indicates a hazard with a low level of risk which, if not avoided, could result in minor or moderate injury.
-  **Warning:** Warning indicates a hazard with a medium level of risk which, if not avoided, could result in death or serious injury.
-  **Danger:** Danger indicates a hazard with a high level of risk which, if not avoided, will result in death or serious injury.

- \*1) ISO 4414: Pneumatic fluid power – General rules relating to systems.
- ISO 4413: Hydraulic fluid power – General rules relating to systems.
- IEC 60204-1: Safety of machinery – Electrical equipment of machines. (Part 1: General requirements)
- ISO 10218-1: Manipulating industrial robots - Safety. etc.

### Warning

- 1. The compatibility of the product is the responsibility of the person who designs the equipment or decides its specifications.**  
Since the product specified here is used under various operating conditions, its compatibility with specific equipment must be decided by the person who designs the equipment or decides its specifications based on necessary analysis and test results. The expected performance and safety assurance of the equipment will be the responsibility of the person who has determined its compatibility with the product. This person should also continuously review all specifications of the product referring to its latest catalogue information, with a view to giving due consideration to any possibility of equipment failure when configuring the equipment.
- 2. Only personnel with appropriate training should operate machinery and equipment.**  
The product specified here may become unsafe if handled incorrectly. The assembly, operation and maintenance of machines or equipment including our products must be performed by an operator who is appropriately trained and experienced.
- 3. Do not service or attempt to remove product and machinery/equipment until safety is confirmed.**
  1. The inspection and maintenance of machinery/equipment should only be performed after measures to prevent falling or runaway of the driven objects have been confirmed.
  2. When the product is to be removed, confirm that the safety measures as mentioned above are implemented and the power from any appropriate source is cut, and read and understand the specific product precautions of all relevant products carefully.
  3. Before machinery/equipment is restarted, take measures to prevent unexpected operation and malfunction.
- 4. Contact SMC beforehand and take special consideration of safety measures if the product is to be used in any of the following conditions.**
  1. Conditions and environments outside of the given specifications, or use outdoors or in a place exposed to direct sunlight.
  2. Installation on equipment in conjunction with atomic energy, railways, air navigation, space, shipping, vehicles, military, medical treatment, combustion and recreation, or equipment in contact with food and beverages, emergency stop circuits, clutch and brake circuits in press applications, safety equipment or other applications unsuitable for the standard specifications described in the product catalogue.
  3. An application which could have negative effects on people, property, or animals requiring special safety analysis.
  4. Use in an interlock circuit, which requires the provision of double interlock for possible failure by using a mechanical protective function, and periodical checks to confirm proper operation.

## Limited warranty and Disclaimer/ Compliance Requirements

The product used is subject to the following “Limited warranty and Disclaimer” and “Compliance Requirements”.  
Read and accept them before using the product.

### Limited warranty and Disclaimer

1. The warranty period of the product is 1 year in service or 1.5 years after the product is delivered, whichever is first.\*2)  
Also, the product may have specified durability, running distance or replacement parts. Please consult your nearest sales branch.
2. For any failure or damage reported within the warranty period which is clearly our responsibility, a replacement product or necessary parts will be provided. This limited warranty applies only to our product independently, and not to any other damage incurred due to the failure of the product.
3. Prior to using SMC products, please read and understand the warranty terms and disclaimers noted in the specified catalogue for the particular products.

\*2) Vacuum pads are excluded from this 1 year warranty.

A vacuum pad is a consumable part, so it is warranted for a year after it is delivered. Also, even within the warranty period, the wear of a product due to the use of the vacuum pad or failure due to the deterioration of rubber material are not covered by the limited warranty.

### Compliance Requirements

1. The use of SMC products with production equipment for the manufacture of weapons of mass destruction (WMD) or any other weapon is strictly prohibited.
2. The exports of SMC products or technology from one country to another are governed by the relevant security laws and regulations of the countries involved in the transaction. Prior to the shipment of a SMC product to another country, assure that all local rules governing that export are known and followed.

### Caution

- 1. The product is provided for use in manufacturing industries.**  
The product herein described is basically provided for peaceful use in manufacturing industries.  
If considering using the product in other industries, consult SMC beforehand and exchange specifications or a contract if necessary.  
If anything is unclear, contact your nearest sales branch.

### Caution

- SMC products are not intended for use as instruments for legal metrology.**  
Measurement instruments that SMC manufactures or sells have not been qualified by type approval tests relevant to the metrology (measurement) laws of each country. Therefore, SMC products cannot be used for business or certification ordained by the metrology (measurement) laws of each country.

## Safety Instructions

Be sure to read “Handling Precautions for SMC Products” (M-E03-3) before using.

### SMC Corporation (Europe)

Austria	☎ +43 (0)2262622800	www.smc.at	office@smc.at	Lithuania	☎ +370 5 2308118	www.smclt.lt	info@smclt.lt
Belgium	☎ +32 (0)33551464	www.smcpnematics.be	info@smcpnematics.be	Netherlands	☎ +31 (0)205318888	www.smcpnematics.nl	info@smcpnematics.nl
Bulgaria	☎ +359 (0)2807670	www.smc.bg	office@smc.bg	Norway	☎ +47 67129020	www.smc-norge.no	post@smc-norge.no
Croatia	☎ +385 (0)13707288	www.smc.hr	office@smc.hr	Poland	☎ +48 222119600	www.smc.pl	office@smc.pl
Czech Republic	☎ +420 541424611	www.smc.cz	office@smc.cz	Portugal	☎ +351 226166570	www.smc.eu	postpt@smc.smces.es
Denmark	☎ +45 70252900	www.smcdk.com	smc@smcdk.com	Romania	☎ +40 213205111	www.smcromania.ro	smcromania@smcromania.ro
Estonia	☎ +372 6510370	www.smcpnematics.ee	smc@smcpnematics.ee	Russia	☎ +7 8127185445	www.smc-pneumatik.ru	info@smc-pneumatik.ru
Finland	☎ +358 207513513	www.smc.fi	smc@smc.fi	Slovakia	☎ +421 (0)413213212	www.smc.sk	office@smc.sk
France	☎ +33 (0)164761000	www.smc-france.fr	info@smc-france.fr	Slovenia	☎ +386 (0)73885412	www.smc.si	office@smc.si
Germany	☎ +49 (0)61034020	www.smc.de	info@smc.de	Spain	☎ +34 902184100	www.smc.eu	post@smc.smces.es
Greece	☎ +30 210 2717265	www.smchellas.gr	sales@smchellas.gr	Sweden	☎ +46 (0)86031200	www.smc.nu	post@smc.nu
Hungary	☎ +36 23511390	www.smc.hu	office@smc.hu	Switzerland	☎ +41 (0)523963131	www.smc.ch	info@smc.ch
Ireland	☎ +353 (0)14039000	www.smcpnematics.ie	sales@smcpnematics.ie	Turkey	☎ +90 212 489 0 440	www.smcpnomatik.com.tr	info@smcpnomatik.com.tr
Italy	☎ +39 0292711	www.smcitalia.it	mailbox@smcitalia.it	UK	☎ +44 (0)845 121 5122	www.smcpnematics.co.uk	sales@smcpnematics.co.uk
Latvia	☎ +371 67817700	www.smc.lv	info@smclv.lv				

SMC CORPORATION Akihbara UDX 15F, 4-14-1, Sotokanda, Chiyoda-ku, Tokyo 101-0021, JAPAN Phone: 03-5207-8249 FAX: 03-5298-5362