



Typical unit

PRODUCT OVERVIEW

The OKL-T/3 series are miniature non-isolated Point-of-Load (PoL) DC/DC power converters for embedded applications. Featuring iLGA inspectable Land Grid Array (LGA) format, the OKL measures only 0.48 x 0.48 x 0.25 inches (12.2 x 12.2 x 6.35 mm).

The wide input range is 4.5 to 14 Volts DC. The maximum output current is 3 Amps (T/3 models). Based on fixed-frequency synchronous buck converter switching topology, the high power conver-

sion efficient Point of Load (PoL) module features programmable output voltage and On/Off control. These converters also include under voltage lock out (UVLO), output short circuit protection, over-current and over temperature protections.

An optional sequence/tracking feature on OKL2 models allows power sequencing of PoLs. These units are designed to meet all standard UL/EN/IEC 60950-1 safety certifications and RoHS-6 hazardous substance compliance.

FEATURES

- iLGA inspectable Land Grid Array
- 4.5-14Vdc input voltage range
- Programmable output voltage from 0.591-5.5Vdc
- Drives up to 200 µF ceramic capacitive loads
- High power conversion efficiency at 93%
- Outstanding thermal derating performance
- Over temperature and over current protection
- On/Off control and Power Good signal
- Optional Sequence/Tracking operation (OKL2 models)
- Designed to meet UL/EN/IEC 60950-1 safety (pending)
- RoHS-6 hazardous substance compliance

Contents

Page

Description, Connection Diagram, Photograph	1
Ordering Guide, Model Numbering, Product Label	2
Mechanical Specifications, Input/Output Pinout	3
Detailed Electrical Specifications	4
Output Voltage Adjustment, Application Notes	5
Soldering Guidelines	7
Performance Data and Oscillograms	8
Tape and Reel Information	15

Connection Diagram

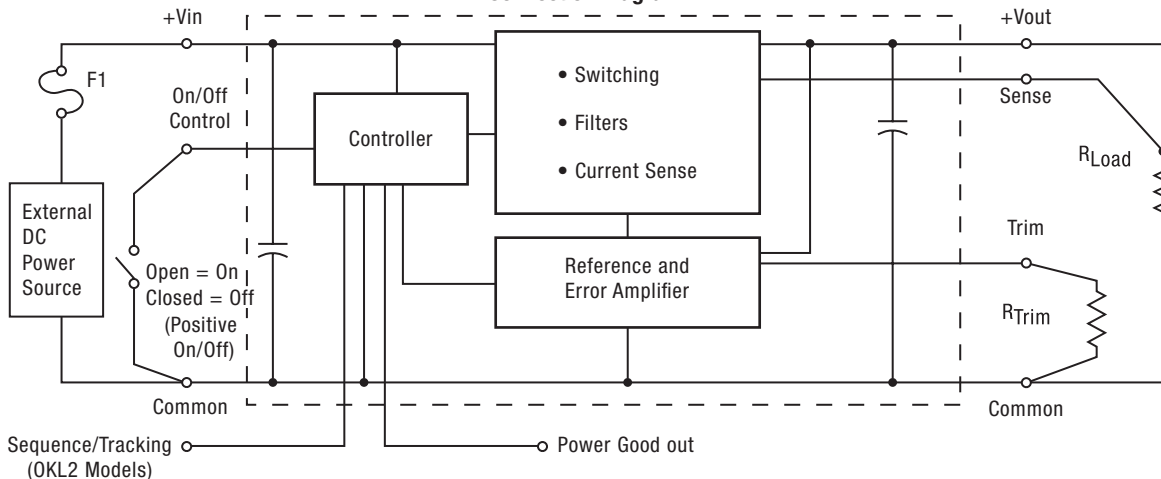

Figure 1. OKL-T/3

Note: Murata Power Solutions strongly recommends an external input fuse, F1. See specifications.



Performance Specifications and Ordering Guide

ORDERING GUIDE																
Model Number	Output					Input				Efficiency		On/Off Polarity	Seq/Track	Package - Pinout P83		
	Vout (Volts) ①	Iout (Amps, max.)	Power (Watts)	R/N (mV p-p) Max. ④	Regulation (max.)		Vin nom. (Volts)	Range (Volts)	Iin, no load (mA) ④	Iin, full load (Amps) ②	Min.			Typ.	Case C83 inches (mm)	
					Line	Load										
OKL-T/3-W12P-C	0.591-5.5	3	15.0	37	±0.25%	±0.25%	12	4.5-14	20	1.34	91%	93%	Pos.	no	0.48x0.48x0.25 12.2x12.2x6.35	
OKL-T/3-W12N-C	0.591-5.5	3	15.0	37	±0.25%	±0.25%	12	4.5-14	20	1.34	91%	93%	Neg.	no	0.48x0.48x0.25 12.2x12.2x6.35	
OKL2-T/3-W12P-C	0.591-5.5	3	15.0	Please contact Murata Power Solutions for further information.										Pos.	yes	0.48x0.48x0.25 12.2x12.2x6.35
OKL2-T/3-W12N-C	0.591-5.5	3	15.0											Neg.	yes	0.48x0.48x0.25 12.2x12.2x6.35

- ① The output range is limited by Vin. See detailed specs.
- ② All specifications are at nominal line voltage, Vout=nominal (5V for W12 models) and full load, +25 deg.C. unless otherwise noted.
Output capacitors are 10 µF ceramic. Input cap is 22 µF. See detailed specifications.
I/O caps are necessary for our test equipment and may not be needed for your application.
- ③ Use adequate ground plane and copper thickness adjacent to the converter.
- ④ Ripple and Noise (R/N) and no-load input current are shown at Vout=1V. See specs for details.

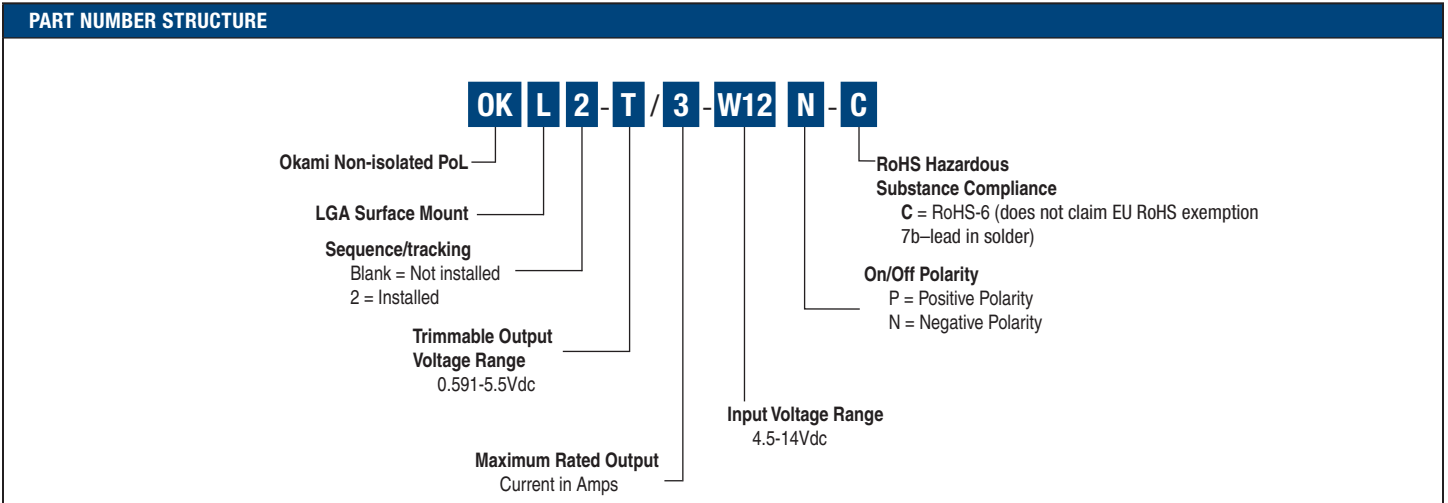

Product Label

Because of the small size of these products, the product label contains a character-reduced code to indicate the model number and manufacturing date code. Not all items on the label are always used. Please note that the label differs from the product photograph. Here is the layout of the label:

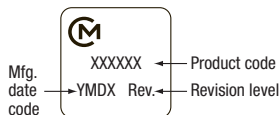

Figure 2. Label Artwork Layout

The label contains three rows of information:

- First row – Murata Power Solutions logo
- Second row – Model number product code (see table)
- Third row – Manufacturing date code and revision level

Model Number	Product Code
OKL-T/3-W12N-C	L00103
OKL-T/3-W12P-C	L01103
OKL2-T/3-W12N-C	L20103
OKL2-T/3-W12P-C	L21103

The manufacturing date code is four characters:

- First character – Last digit of manufacturing year, example 2009
- Second character – Month code (1 through 9 and 0 through D)
- Third character – Day code (1 through 9 = 1 to 9, 10=0 and 11 through 31 = A through Z)
- Fourth character – Manufacturing information

MECHANICAL SPECIFICATIONS

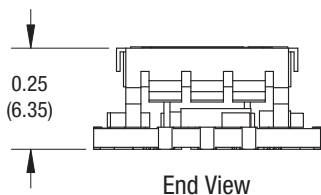
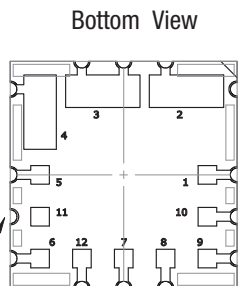
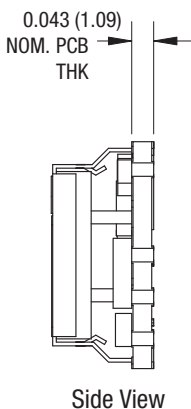
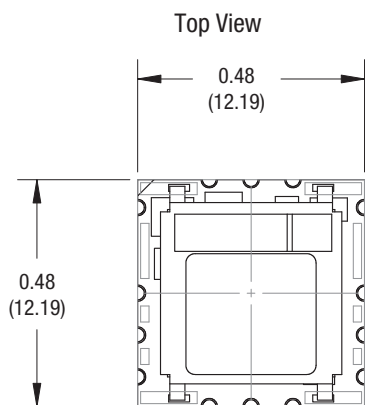

INPUT/OUTPUT CONNECTIONS	
Pin	Function
1	On/Off Control*
2	V _{IN}
3	Ground
4	V _{OUT}
5	Sense
6	Trim
7	Ground
8	NC
9	Sequence/Tracking†
10	Power Good out
11	NC
12	NC

NOTE:
In case of solder-wicking, this terminal is connected to V_{out}.

*The Remote On/Off can be provided with either positive (P suffix) or negative (N suffix) polarity

† OKL2 Models

Bottom View

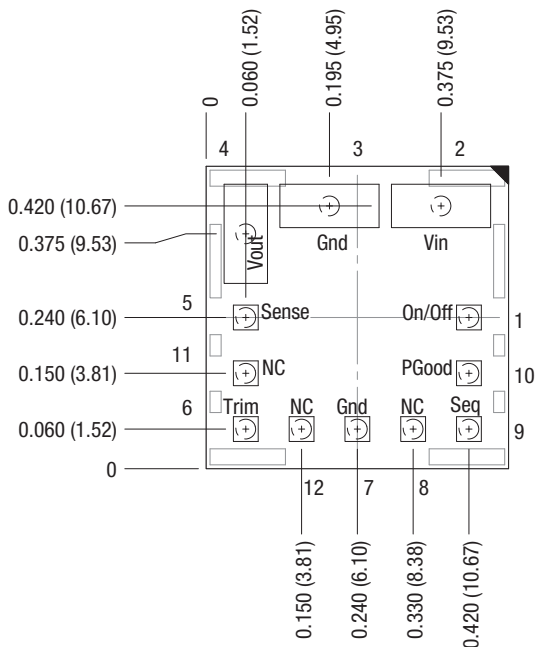

Recommended Footprint -through the Board-

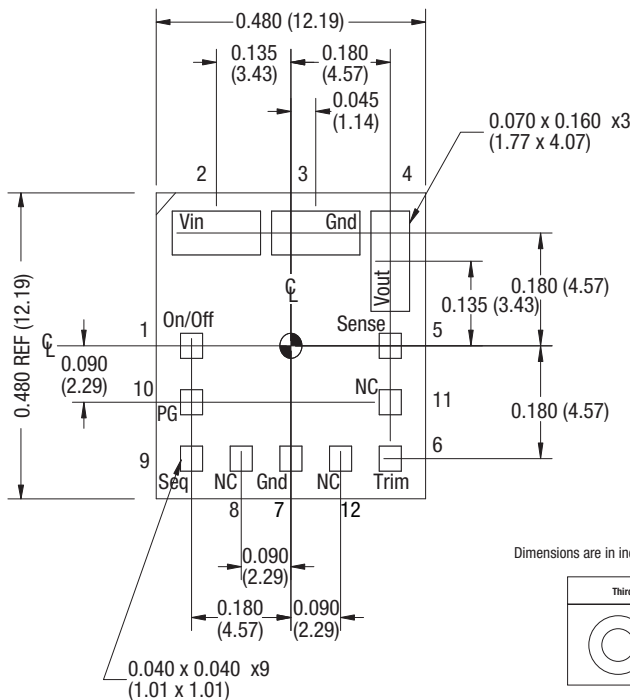

Dimensions are in inches (mm shown for ref. only).

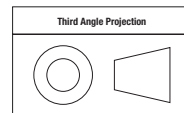

Tolerances (unless otherwise specified):
.XX ± 0.02 (0.5)
.XXX ± 0.010 (0.25)
Angles ± 1°

Components are shown for reference only.

Figure 3. OKL-T/3 Mechanical Outline

Performance and Functional Specifications

See Note 1

Input	
Input Voltage Range	See Ordering Guide and Note 7.
Isolation	Not isolated
Start-Up Voltage	4.2 V
Undervoltage Shutdown (see Note 15)	3.4 V
Overvoltage Shutdown	None
Reflected (Back) Ripple Current (Note 2)	49 mA pk-pk
Internal Input Filter Type	Capacitive
Recommended External Fuse	4A
Reverse Polarity Protection	None. See fuse information.
Input Current:	
Full Load Conditions	See Ordering Guide
Inrush Transient	0.16 A ² Sec.
Shutdown Mode (Off, UV, OT)	1 mA
Output in Short Circuit	5 mA
Low Line (Vin=Vmin)	2.24 A.
Remote On/Off Control (Note 5)	
Negative Logic ("N" model suffix)	ON = Open pin or -0.2V to +0.3V. max. OFF = +3.5V min. to +Vin
Positive Logic ("P" model suffix)	ON = Open pin (internally pulled up) or +3.5V to +Vin max. OFF = -0.3V to +0.4V. max. or ground
Current	1 mA max.
Tracking/Sequencing (OKL "2" models)	
Slew Rate	2 Volts per millisecond, max.
Tracking accuracy, rising input	Vout = +/-100 mV of Sequence In
Tracking accuracy, falling input	Vout = +/-200 mV of Sequence In
Output	
Output Power	15.23W max.
Output Voltage Range	See Ordering Guide
Minimum Loading	No minimum load
Accuracy (50% load, untrimmed)	±1.5 % of Vnominal
Voltage Output Range (Note 13)	See Ordering Guide
Overvoltage Protection (Note 16)	None
Temperature Coefficient	±0.02% per °C of Vout range
Ripple/Noise (20 MHz bandwidth)	See Ordering Guide and note 8
Line/Load Regulation	See Ordering Guide and note 10
Efficiency	See Ordering Guide
Maximum Capacitive Loading (Note 14)	
Cap-ESR=0.001 to 0.01 Ohms	200 µF
Cap-ESR >0.01 Ohms	TBD
Current Limit Inception (Note 6)	
(98% of Vout setting, after warm up)	6 Amps
Short Circuit Mode	
Short Circuit Current Output	10 mA
Protection Method	Hiccup autorecovery upon overload removal. (Note 17)
Short Circuit Duration	Continuous, no damage (output shorted to ground)
Prebias Startup	Converter will start up if the external output voltage is less than Vnominal.
Power Good output	
PGood TRUE (HI)	open drain configuration, 10 mA sink (Vset -10%) < Vout < (Vset +10%)
PGood FALSE (LO)	0.0V < Vout < 0.4V
Dynamic Characteristics	
Dynamic Load Response	200µSec max. to within ±2% of final value
(50-100% load step, di/dt=1A/µSec)	(Note 1)

Peak Deviation	250 mV
Start-Up Time	6 mSec for Vout=nominal (Vin On)
(Vin on or On/Off to Vout regulated)	6 mSec for Vout=nominal (Remote On/Off)
Switching Frequency	600 KHz

Environmental	
Calculated MTBF	
Telecordia method (4a)	TBD
Calculated MTBF	
MIL-HDBK-217N2 method (4b)	TBD
Operating Temperature Range (Ambient, vertical mount)	
See derating curves	-40 to +85 °C. with derating (Note 9)
Storage Temperature Range	-55 to +125 deg. C.
Thermal Protection/Shutdown	TBD
Relative Humidity	to 85%/+85 °C., non-condensing

Physical	
Outline Dimensions	See Mechanical Specifications
Weight	0.06 ounces (1.6 grams)
Safety	Designed to meet UL/cUL 60950-1, CSA-C22.2 No. 60950-1, IEC/EN 60950-1 (pending)
Restriction of Hazardous Substances	RoHS-6 (does not claim EU RoHS exemption 7b-lead in solder)
MSL Rating	TBD

Absolute Maximum Ratings	
Input Voltage (Continuous or transient)	0 V. to +15 Volts max.
On/Off Control	0 V. min. to +Vin max.
Input Reverse Polarity Protection	See Fuse section
Output Current (Note 7)	Current-limited. Devices can withstand a sustained short circuit without damage. The outputs are not intended to accept appreciable reverse current.
Storage Temperature	-55 to +125 °C.
Lead Temperature	See soldering specifications

Absolute maximums are stress ratings. Exposure of devices to greater than any of any of these conditions may adversely affect long-term reliability. Proper operation under conditions other than those listed in the Performance/Functional Specifications Table is not implied nor recommended.

Specification Notes:

- Specifications are typical at +25 °C, Vin=nominal (+12V), Vout=nominal (+5V), full load, external caps and natural convection unless otherwise indicated. Extended tests at full power must supply substantial forced airflow.
All models are tested and specified with external 10µF ceramic output capacitors and a 22 µF external input capacitor. All capacitors are low ESR types. These capacitors are necessary to accommodate our test equipment and may not be required to achieve specified performance in your applications. However, Murata Power Solutions recommends installation of these capacitors. All models are stable and regulate within spec under no-load conditions.
- Input Back Ripple Current is tested and specified over a 5 Hz to 20 MHz bandwidth. Input filtering is Cin=2 x 100 µF ceramic, Cbus=1000 µF electrolytic, Lbus=1 µH.
- Note that Maximum Power Derating curves indicate an average current at nominal input voltage. At higher temperatures and/or lower airflow, the DC/DC converter will tolerate brief full current outputs if the total RMS current over time does not exceed the Derating curve.
- Mean Time Before Failure is calculated using the Telcordia (Belcore) SR-332 Method 1, Case 3, ground fixed conditions, Tpcboard=+25 °C, full output load, natural air convection.
- Mean Time Before Failure is calculated using the MIL-HDBK-217N2 method, ground benign, +25°C., full output load, natural convection.
- The On/Off Control Input should use either a switch or an open collector/open drain transistor referenced to -Input Common. A logic gate may also be used by applying appropriate external voltages which do not exceed +Vin.
- Short circuit shutdown begins when the output voltage degrades approximately 2% from the selected setting.

Specification Notes, Cont.:

- (7) Please observe the voltage input and output specifications in the Voltage Range Graph on page 7.
- (8) Output noise may be further reduced by adding an external filter. At zero output current, the output may contain low frequency components which exceed the ripple specification. The output may be operated indefinitely with no load.
- (9) All models are fully operational and meet published specifications, including "cold start" at -40° C.
- (10) Regulation specifications describe the deviation as the line input voltage or output load current is varied from a nominal midpoint value to either extreme.
- (11) Other input or output voltage ranges will be reviewed under scheduled quantity special order.
- (12) Maximum PC board temperature is measured with the sensor in the center of the converter.
- (13) Do not exceed maximum power specifications when adjusting the output trim.
- (14) The maximum output capacitive loads depend on the the Equivalent Series Resistance (ESR) of the external output capacitor and, to a lesser extent, the distance and series impedance to the load. Larger caps will reduce output noise but may change the transient response. Newer ceramic caps with very low ESR may require lower capacitor values to avoid instability. Thoroughly test your capacitors in the application. Please refer to the Output Capacitive Load Application Note.
- (15) Do not allow the input voltage to degrade lower than the input undervoltage shutdown voltage at all times. Otherwise, you risk having the converter turn off. The undervoltage shutdown is not latching and will attempt to recover when the input is brought back into normal operating range.
- (16) The outputs are not intended to sink appreciable reverse current.
- (17) "Hiccup" overcurrent operation repeatedly attempts to restart the converter with a brief, full-current output. If the overcurrent condition still exists, the restart current will be removed and then tried again. This short current pulse prevents overheating and damaging the converter. Once the fault is removed, the converter immediately recovers normal operation.

Output Voltage Adjustment

The output voltage may be adjusted over a limited range by connecting an external trim resistor (Rtrim) between the Trim pin and Ground. The Rtrim resistor must be a 1/10 Watt precision metal film type, ±0.5% accuracy or better with low temperature coefficient, ±100 ppm/oC. or better. Mount the resistor close to the converter with very short leads or use a surface mount trim resistor.

In the tables below, the calculated resistance is given. Do not exceed the specified limits of the output voltage or the converter's maximum power rating when applying these resistors. Also, avoid high noise at the Trim input. However, to prevent instability, you should never connect any capacitors to Trim.

OKL-T/3-W12

Output Voltage	Calculated Rtrim (KΩ)
5.0 V.	1.34
3.3 V.	2.18
2.5 V.	3.1
2.0 V.	4.19
1.8 V.	4.88
1.5 V.	6.50
1.2 V.	9.70
1.0 V.	14.45
0.591 V.	∞ (open)

Resistor Trim Equation, OKL models:

$$R_{TRIM} (k\Omega) = \frac{5.91}{V_{OUT} - 0.591}$$

APPLICATION NOTES

Input Fusing

Certain applications and/or safety agencies may require fuses at the inputs of power conversion components. Fuses should also be used when there is the possibility of sustained input voltage reversal which is not current-limited. For greatest safety, we recommend a fast blow fuse installed in the ungrounded input supply line.

The installer must observe all relevant safety standards and regulations. For safety agency approvals, install the converter in compliance with the end-user safety standard, i.e. IEC/EN/UL 60950-1.

Input Under-Voltage Shutdown and Start-Up Threshold

Under normal start-up conditions, converters will not begin to regulate properly until the ramping-up input voltage exceeds and remains at the Start-Up Threshold Voltage (see Specifications). Once operating, converters will not turn off until the input voltage drops below the Under-Voltage Shutdown Limit. Subsequent restart will not occur until the input voltage rises again above the Start-Up Threshold. This built-in hysteresis prevents any unstable on/off operation at a single input voltage.

Users should be aware however of input sources near the Under-Voltage Shutdown whose voltage decays as input current is consumed (such as capacitor inputs), the converter shuts off and then restarts as the external capacitor recharges. Such situations could oscillate. To prevent this, make sure the operating input voltage is well above the UV Shutdown voltage AT ALL TIMES.

Start-Up Time

Assuming that the output current is set at the rated maximum, the Vin to Vout Start-Up Time (see Specifications) is the time interval between the point when the ramping input voltage crosses the Start-Up Threshold and the fully loaded regulated output voltage enters and remains within its specified accuracy band. Actual measured times will vary with input source impedance, external input capacitance, input voltage slew rate and final value of the input voltage as it appears at the converter.

These converters include a soft start circuit to moderate the duty cycle of its PWM controller at power up, thereby limiting the input inrush current.

The On/Off Remote Control interval from On command to Vout regulated assumes that the converter already has its input voltage stabilized above the Start-Up Threshold before the On command. The interval is measured from the On command until the output enters and remains within its specified accuracy band. The specification assumes that the output is fully loaded at maximum rated current. Similar conditions apply to the On to Vout regulated specification such as external load capacitance and soft start circuitry.

Recommended Input Filtering

The user must assure that the input source has low AC impedance to provide dynamic stability and that the input supply has little or no inductive content, including long distributed wiring to a remote power supply. The converter will operate with no additional external capacitance if these conditions are met.

For best performance, we recommend installing a low-ESR capacitor immediately adjacent to the converter's input terminals. The capacitor should be a ceramic type such as the Murata GRM32 series or a polymer type. Initial suggested capacitor values are 10 to 22 μF , rated at twice the expected maximum input voltage. Make sure that the input terminals do not go below the undervoltage shutdown voltage at all times. More input bulk capacitance may be added in parallel (either electrolytic or tantalum) if needed.

Recommended Output Filtering

The converter will achieve its rated output ripple and noise with no additional external capacitor. However, the user may install more external output capacitance to reduce the ripple even further or for improved dynamic response. Again, use low-ESR ceramic (Murata GRM32 series) or polymer capacitors. Initial values of 10 to 47 μF may be tried, either single or multiple capacitors in parallel. Mount these close to the converter. Measure the output ripple under your load conditions.

Use only as much capacitance as required to achieve your ripple and noise objectives. Excessive capacitance can make step load recovery sluggish or possibly introduce instability. Do not exceed the maximum rated output capacitance listed in the specifications.

Input Ripple Current and Output Noise

All models in this converter series are tested and specified for input reflected ripple current and output noise using designated external input/output components, circuits and layout as shown in the figures below. The Cbus and Lbus components simulate a typical DC voltage bus. Please note that the values of Cin, Lbus and Cbus will vary according to the specific converter model.

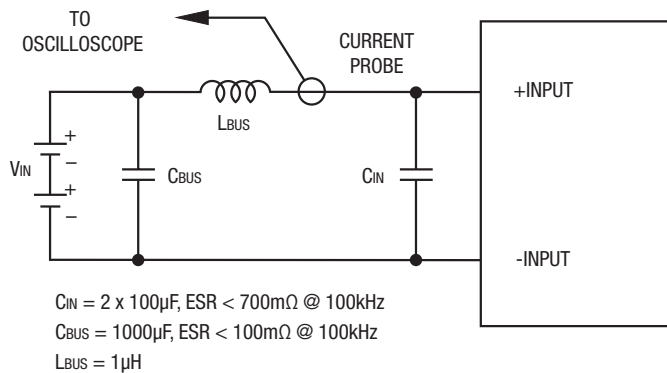

Figure 4: Measuring Input Ripple Current

In figure 5, the two copper strips simulate real-world printed circuit impedances between the power supply and its load. In order to minimize circuit errors and standardize tests between units, scope measurements should be made using BNC connectors or the probe ground should not exceed one half inch and soldered directly to the test circuit.

Minimum Output Loading Requirements

All models regulate within specification and are stable under no load to full load conditions. Operation under no load might however slightly increase output ripple and noise.

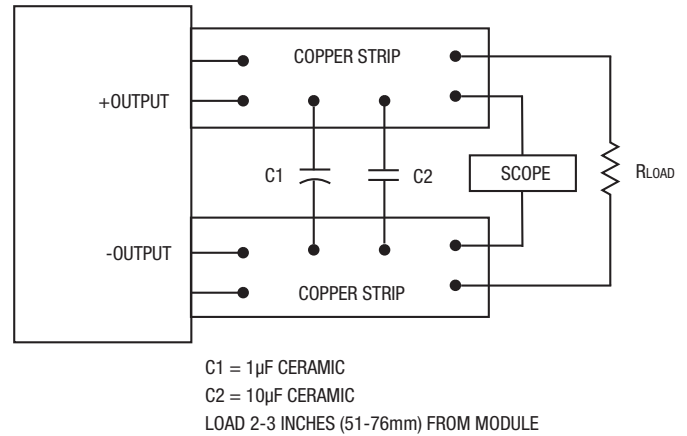

Figure 5: Measuring Output Ripple and Noise (PARD)

Thermal Shutdown

To prevent many over temperature problems and damage, these converters include thermal shutdown circuitry. If environmental conditions cause the temperature of the DC/DC's to rise above the Operating Temperature Range up to the shutdown temperature, an on-board electronic temperature sensor will power down the unit. When the temperature decreases below the turn-on threshold, the converter will automatically restart. There is a small amount of hysteresis to prevent rapid on/off cycling.

CAUTION: If you operate too close to the thermal limits, the converter may shut down suddenly without warning. Be sure to thoroughly test your application to avoid unplanned thermal shutdown.

Temperature Derating Curves

The graphs in the next section illustrate typical operation under a variety of conditions. The Derating curves show the maximum continuous ambient air temperature and decreasing maximum output current which is acceptable under increasing forced airflow measured in Linear Feet per Minute ("LFM"). Note that these are AVERAGE measurements. The converter will accept brief increases in current or reduced airflow as long as the average is not exceeded.

Note that the temperatures are of the ambient airflow, not the converter itself which is obviously running at higher temperature than the outside air. Also note that very low flow rates (below about 25 LFM) are similar to "natural convection", that is, not using fan-forced airflow.

Murata Power Solutions makes Characterization measurements in a closed cycle wind tunnel with calibrated airflow. We use both thermocouples and an infrared camera system to observe thermal performance.

CAUTION: If you routinely or accidentally exceed these Derating guidelines, the converter may have an unplanned Over Temperature shut down. Also, these graphs are all collected at slightly above Sea Level altitude. Be sure to reduce the derating for higher density altitude.

Output Current Limiting

Current limiting inception is defined as the point at which full power falls below the rated tolerance. See the Performance/Functional Specifications. Note particularly that the output current may briefly rise above its rated value in normal operation as long as the average output power is not exceeded. This enhances reliability and continued operation of your application. If the output current is too high, the converter will enter the short circuit condition.

Output Short Circuit Condition

When a converter is in current-limit mode, the output voltage will drop as the output current demand increases. If the output voltage drops too low (approximately 98% of nominal output voltage for most models), the magnetically coupled voltage used to develop primary side voltages will also drop, thereby shutting down the PWM controller. Following a time-out period, the PWM will restart, causing the output voltage to begin ramping up to its appropriate value. If the short-circuit condition persists, another shutdown cycle will initiate. This rapid on/off cycling is called “hiccup mode”. The hiccup cycling reduces the average output current, thereby preventing excessive internal temperatures and/or component damage. A short circuit can be tolerated indefinitely.

The “hiccup” system differs from older latching short circuit systems because you do not have to power down the converter to make it restart. The system will automatically restore operation as soon as the short circuit condition is removed.

Remote On/Off Control

The remote On/Off Control can be ordered with either polarity. Please refer to the Connection Diagram on page 1 for On/Off connections.

Positive polarity models are enabled when the On/Off pin is left open or is pulled high to +Vin with respect to –Vin. An internal bias current causes the open pin to rise to +Vin. Positive-polarity devices are disabled when the On/Off is grounded or brought to within a low voltage (see Specifications) with respect to –Vin.

Negative polarity devices are on (enabled) when the On/Off is open or brought to within a low voltage (see Specifications) with respect to –Vin. The device is off (disabled) when the On/Off is pulled high with respect to –Vin (see specifications).

Dynamic control of the On/Off function should be able to sink appropriate signal current when brought low and withstand appropriate voltage when brought high. Be aware too that there is a finite time in milliseconds (see Specifications) between the time of On/Off Control activation and stable, regulated output. This time will vary slightly with output load type and current and input conditions.

Output Capacitive Load

These converters do not require external capacitance added to achieve rated specifications. Users should only consider adding capacitance to reduce switching noise and/or to handle spike current load steps. Install only enough capacitance to achieve noise objectives. Excess external capacitance may cause regulation problems, degraded transient response and possible oscillation or instability.

Voltage Range Graph

Please observe the limits below for voltage input and output ranges. These limits apply at all output currents.

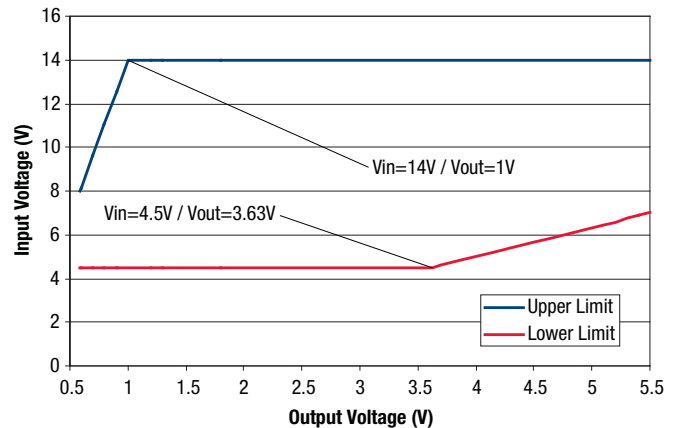

Soldering Guidelines

Murata Power Solutions recommends the specifications below when installing these converters. These specifications vary depending on the solder type. Exceeding these specifications may cause damage to the product. Your production environment may differ therefore please thoroughly review these guidelines with your process engineers.

Reflow Solder Operations for surface-mount products (SMT)	
For Sn/Ag/Cu based solders:	
Preheat Temperature	Less than 1 °C. per second
Time over Liquidus	45 to 75 seconds
Maximum Peak Temperature	260 °C.
Cooling Rate	Less than 3 °C. per second
For Sn/Pb based solders:	
Preheat Temperature	Less than 1 °C. per second
Time over Liquidus	60 to 75 seconds
Maximum Peak Temperature	235 °C.
Cooling Rate	Less than 3 °C. per second

Recommended Lead-free Solder Reflow Profile

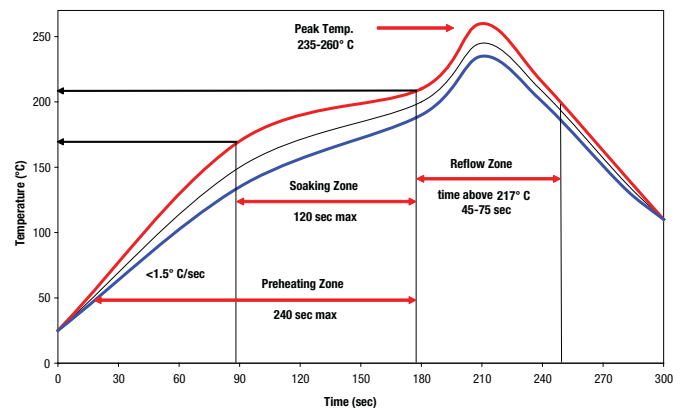

High trace = normal upper limit

Low trace - normal lower limit

OKL-T/3-W12 PERFORMANCE DATA AND OSCILLOGRAMS

OKL2-T/3-W12 Efficiency vs. Line Voltage and Load Current +25 °C
(Vout = 5V)

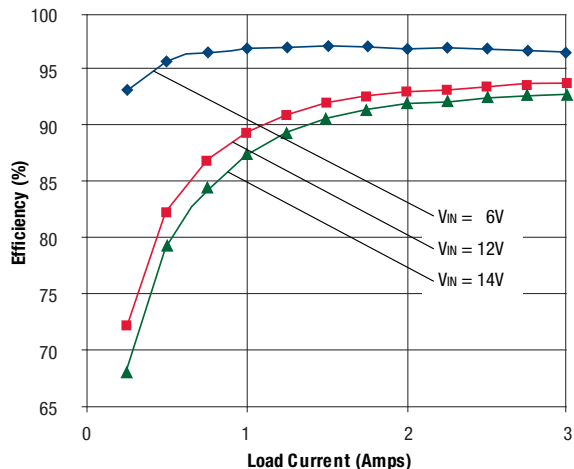

OKL-T/3-W12 Maximum Current Temperature Derating at Sea Level
(VIN = 12V, VOUT = 5V)

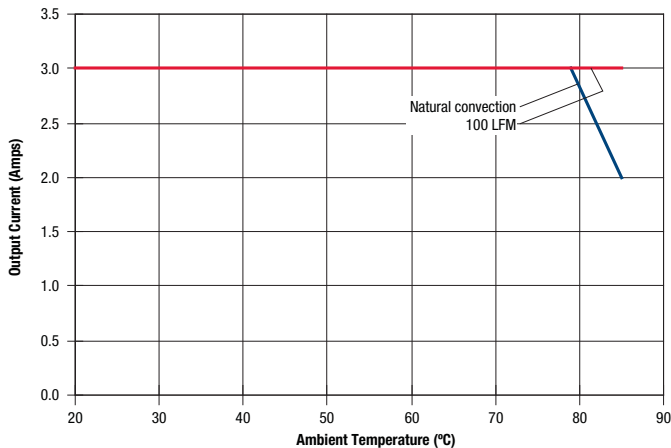

On/Off Enable Startup Delay (Vin=12V, Vout=5.0V, Iout=3A, Clad=0)
Trace 4=Enable In, Trace2=Vout

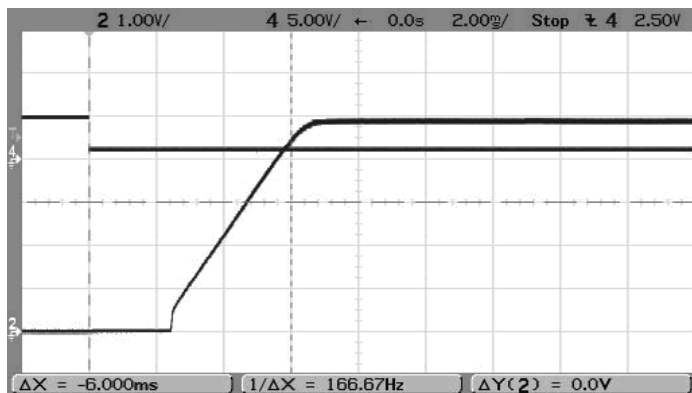

Output Ripple and Noise (Vin=12V, Vout=5.0V, Iout=3A, Clad=0, ScopeBW=20MHz)

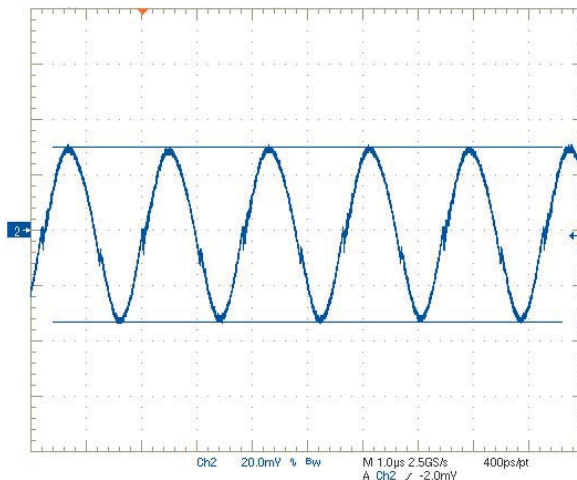

Step Load Transient Response (Vin=12V, Vout=5.0V, Clad=0, Iout=1.5A to 3A)
Trace 2=Vout, 100 mV/div. Trace 4=Iout, 1A/div.

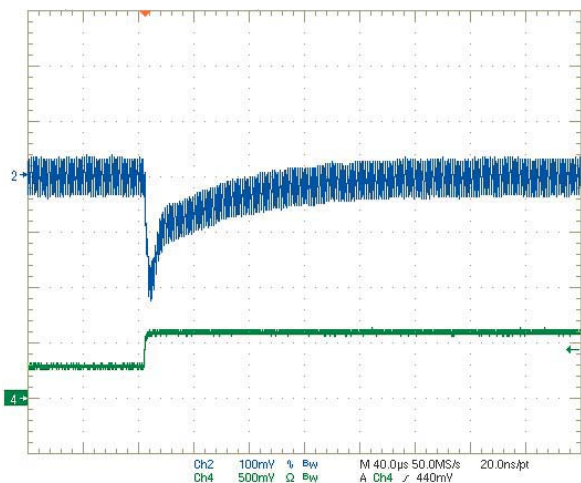

Step Load Transient Response (Vin=12V, Vout=5.0V, Clad=0, Iout=3A to 1.5A)
Trace 2=Vout, 100 mV/div. Trace 4=Iout, 1A/div.

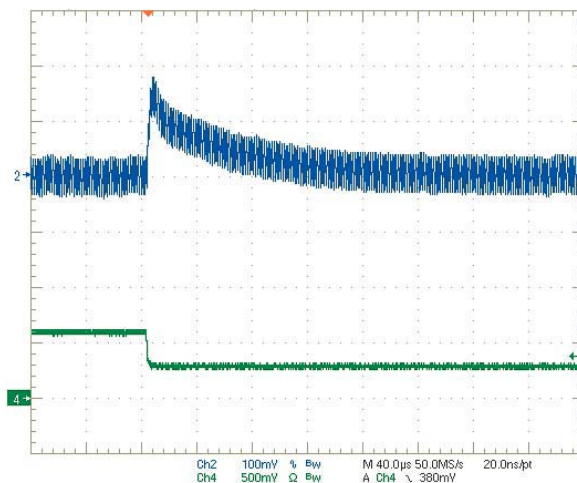

OKL-T/3-W12 PERFORMANCE DATA AND OSCILLOGRAMS

OKL2-T/3-W12 Efficiency vs. Line Voltage and Load Current +25 °C
(Vout = 3.3V)

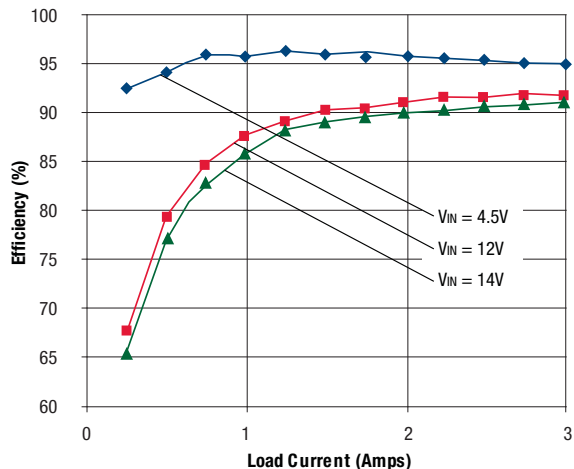

OKL-T/3-W12 Maximum Current Temperature Derating at Sea Level
(VIN = 12V, VOUT = 3.3V)

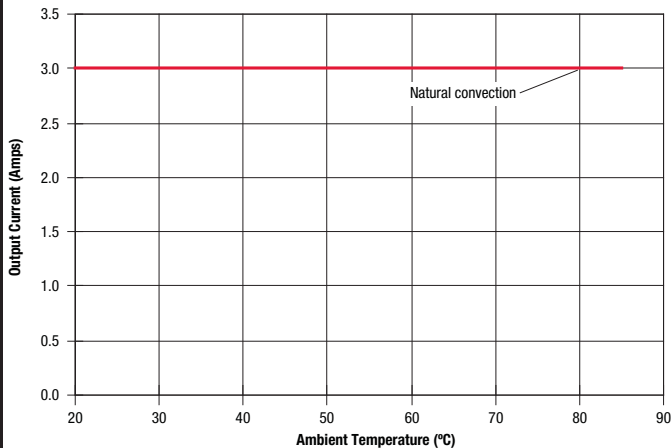

On/Off Enable Startup Delay (Vin=12V, Vout=3.3V, Iout=3A, Cload=0)
Trace 4=Enable In, Trace2=Vout

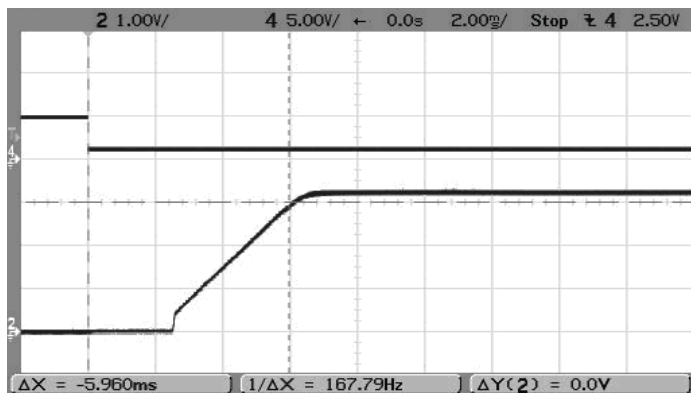

Output Ripple and Noise (Vin=12V, Vout=3.3V, Iout=3A, Cload=0, ScopeBW=20MHz)

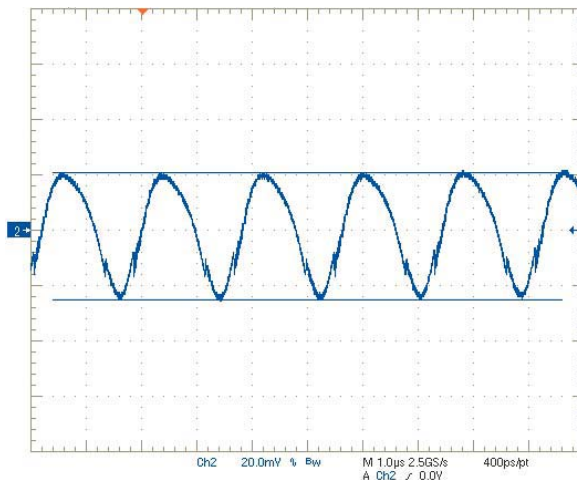

Step Load Transient Response (Vin=12V, Vout=3.3V, Cload=0, Iout=1.5A to 3A)
Trace 2=Vout, 100 mV/div. Trace 4=Iout, 1A/div.

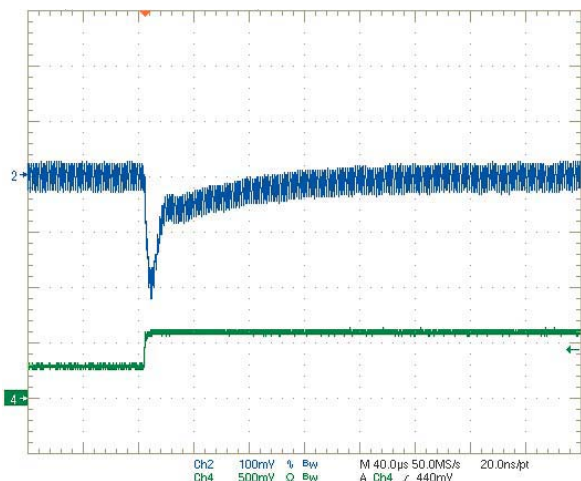

Step Load Transient Response (Vin=12V, Vout=3.3V, Cload=0, Iout=3A to 1.5A)
Trace 2=Vout, 100 mV/div. Trace 4=Iout, 1A/div.

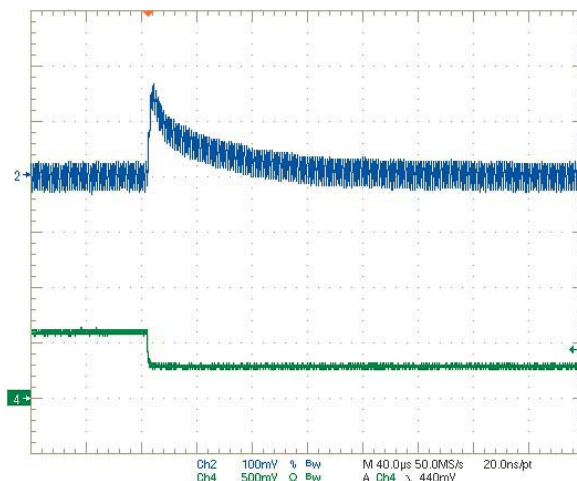

OKL-T/3-W12 PERFORMANCE DATA AND OSCILLOGRAMS

OKL2-T/3-W12 Efficiency vs. Line Voltage and Load Current +25 °C
(Vout = 2.5V)

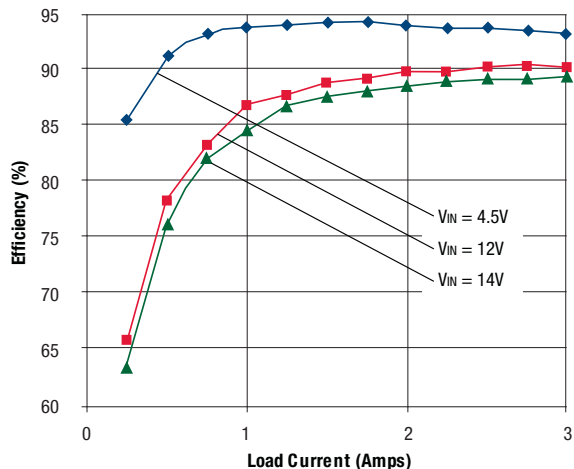

OKL-T/3-W12 Maximum Current Temperature Derating at Sea Level
(VIN = 12V, VOUT = 2.5V)

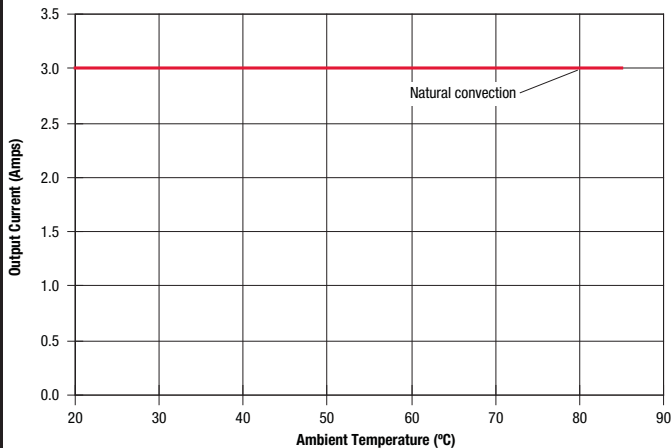

On/Off Enable Startup Delay (Vin=12V, Vout=2.5V, Iout=3A, Load=0)
Trace 4=Enable In, Trace 2=Vout

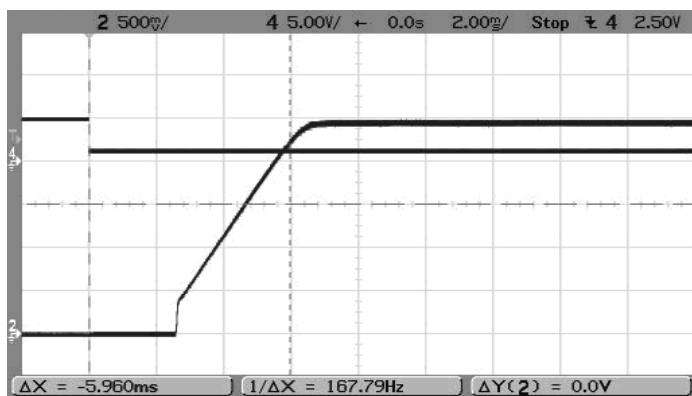

Output Ripple and Noise (Vin=12V, Vout=2.5V, Iout=3A, Load=0, ScopeBW=20MHz)

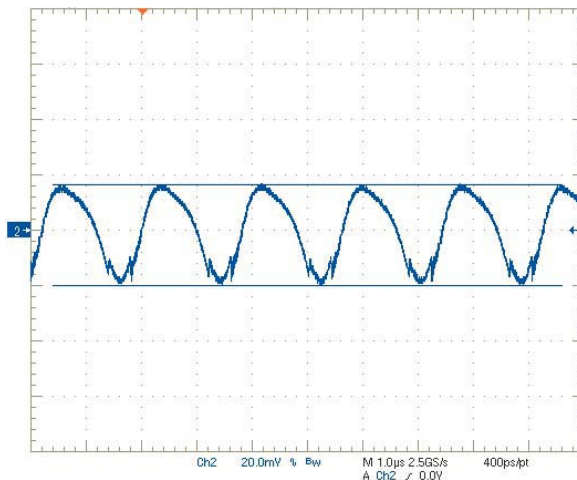

Step Load Transient Response (Vin=12V, Vout=2.5V, Load=0, Iout=1.5A to 3A)
Trace 2=Vout, 100 mV/div. Trace 4=Iout, 1A/div.

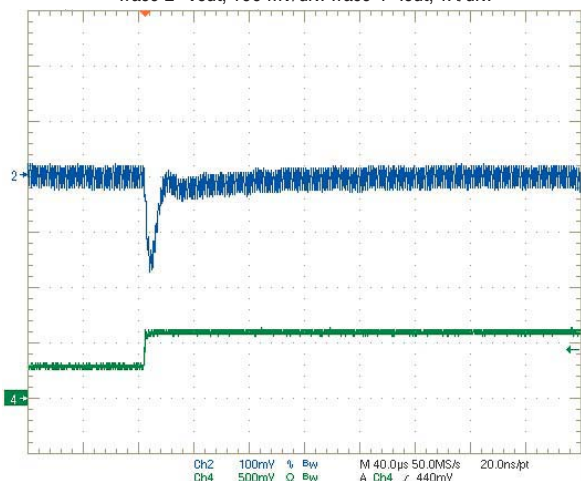

Step Load Transient Response (Vin=12V, Vout=2.5V, Load=0, Iout=3A to 1.5A)
Trace 2=Vout, 100 mV/div. Trace 4=Iout, 1A/div.

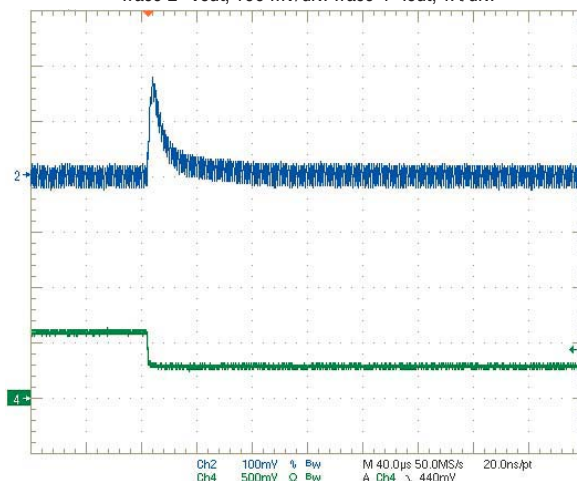

OKL-T/3-W12 PERFORMANCE DATA AND OSCILLOGRAMS

Output Ripple and Noise (Vin=12V, Vout=1.8V, Iout=3A, Cload=0, ScopeBW=20MHz)

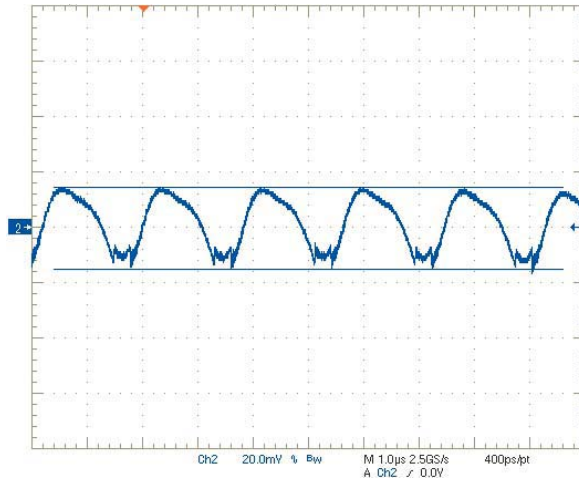

Step Load Transient Response (Vin=12V, Vout=1.8V, Cload=0, Iout=1.5A to 3A)

Trace 2=Vout, 100 mV/div. Trace 4=Iout, 1A/div.

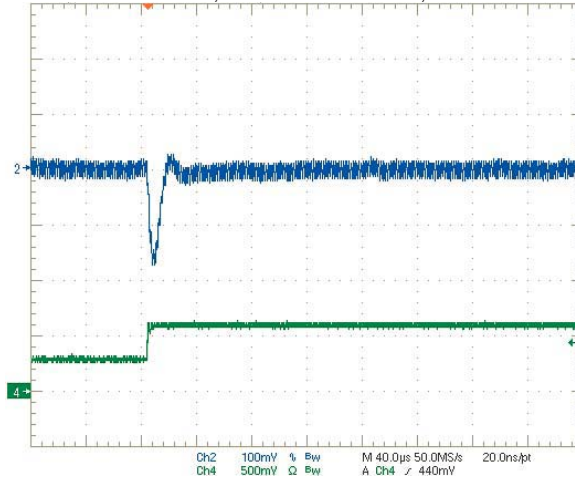

Step Load Transient Response (Vin=12V, Vout=1.8V, Cload=0, Iout=3A to 1.5A)

Trace 2=Vout, 100 mV/div. Trace 4=Iout, 1A/div.

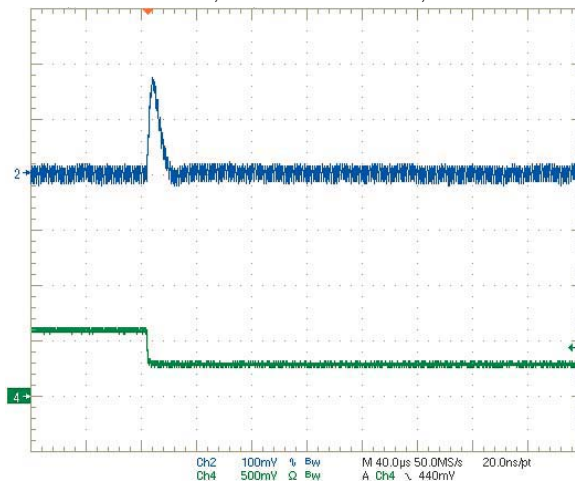

OKL-T/3-W12 PERFORMANCE DATA AND OSCILLOGRAMS

OKL2-T/3-W12 Efficiency vs. Line Voltage and Load Current +25 °C
(Vout = 1.2V)

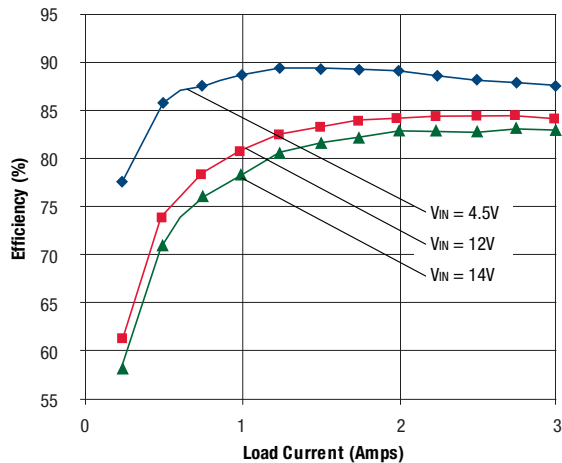

OKL-T/3-W12 Maximum Current Temperature Derating at Sea Level
(VIN = 12V, VOUT = 1.2V)

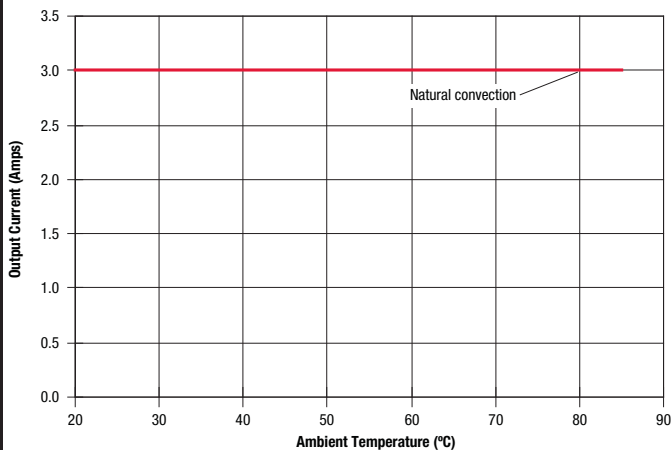

On/Off Enable Startup Delay (Vin=12V, Vout=1.2V, Iout=3A, Clod=0)
Trace 4=Enable In, Trace2=Vout

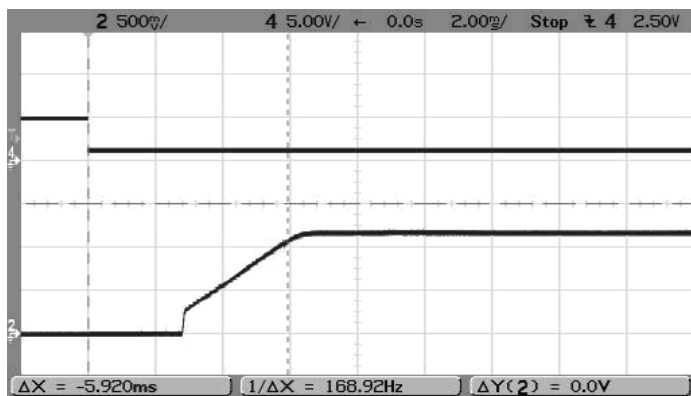

Output Ripple and Noise (Vin=12V, Vout=1.2V, Iout=3A, Clod=0, ScopeBW=20MHz)

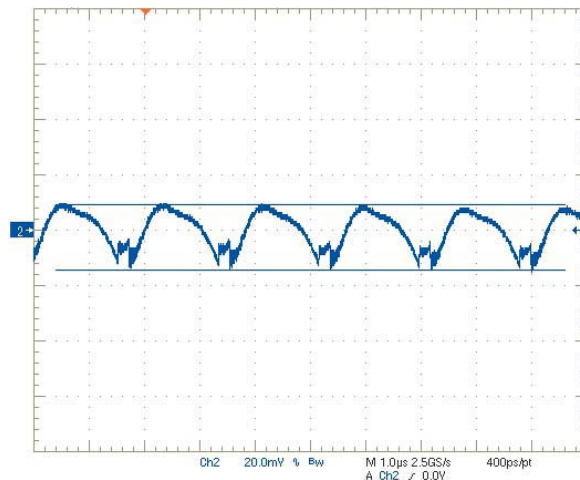

Step Load Transient Response (Vin=12V, Vout=1.2V, Clod=0, Iout=1.5A to 3A)
Trace 2=Vout, 100 mV/div. Trace 4=Iout, 1A/div.

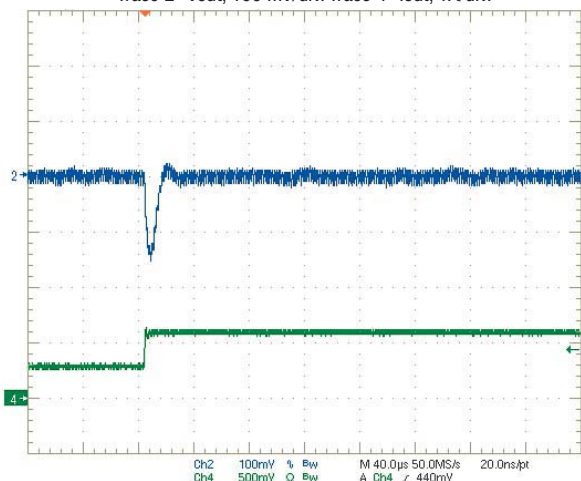

Step Load Transient Response (Vin=12V, Vout=1.2V, Clod=0, Iout=3A to 1.5A)
Trace 2=Vout, 100 mV/div. Trace 4=Iout, 1A/div.

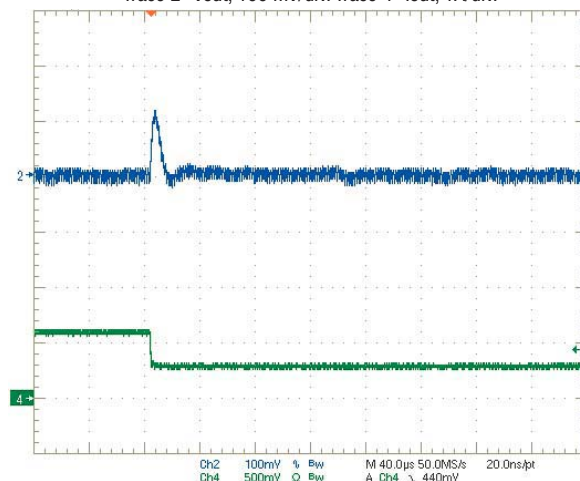

OKL-T/3-W12 PERFORMANCE DATA AND OSCILLOGRAMS

Output Ripple and Noise (Vin=12V, Vout=1.0V, Iout=3A, Cload=0, ScopeBW=20MHz)



Step Load Transient Response (Vin=12V, Vout=1.0V, Cload=0, Iout=1.5A to 3A)

Trace 2=Vout, 100 mV/div. Trace 4=Iout, 1A/div.

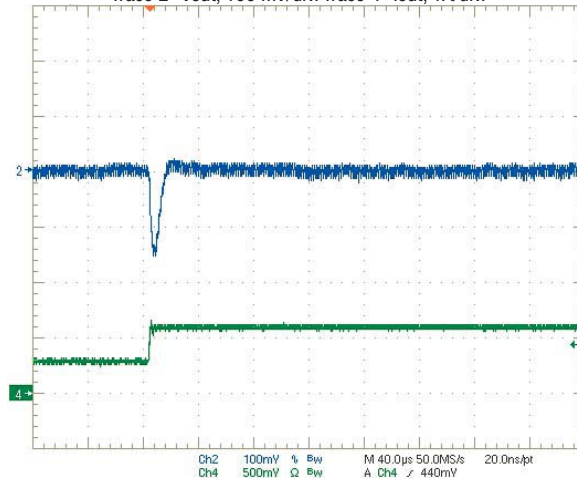

Step Load Transient Response (Vin=12V, Vout=1.0V, Cload=0, Iout=3A to 1.5A)

Trace 2=Vout, 100 mV/div. Trace 4=Iout, 1A/div.

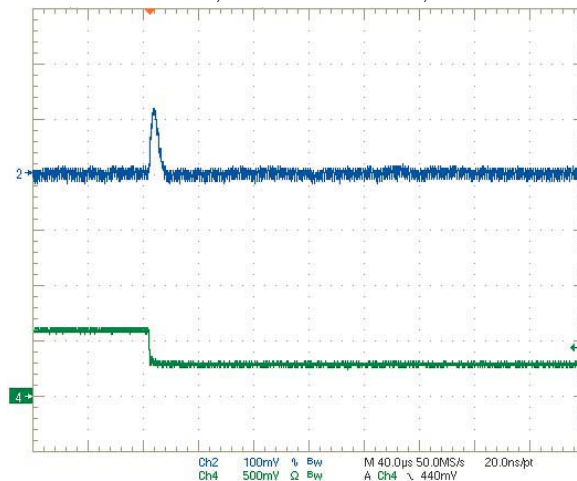

OKL-T/3-W12 PERFORMANCE DATA AND OSCILLOGRAMS

OKL2-T/3-W12 Efficiency vs. Line Voltage and Load Current +25 °C
(Vout = 0.591V)

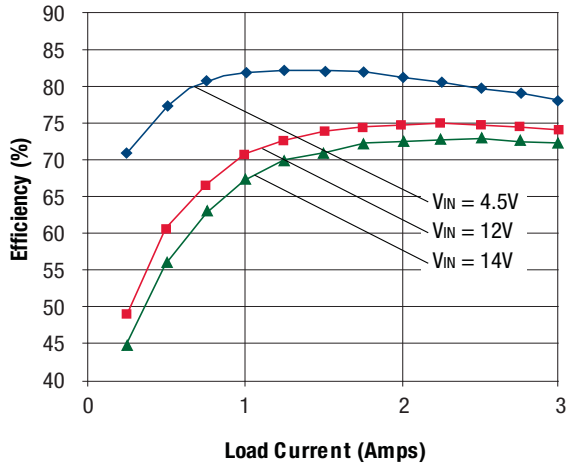

OKL-T/3-W12 Maximum Current Temperature Derating at Sea Level
(Vin = 12V, Vout = 0.591V)

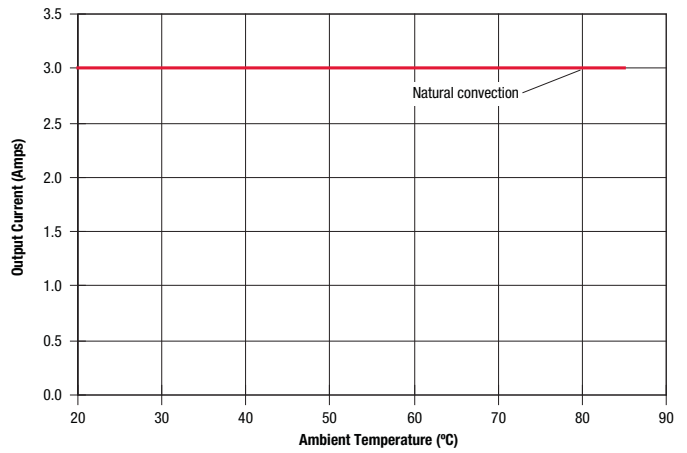

On/Off Enable Startup Delay (Vin=12V, Vout=0.591V, Iout=3A, Cloud=0)
Trace 4=Enable In, Trace2=Vout

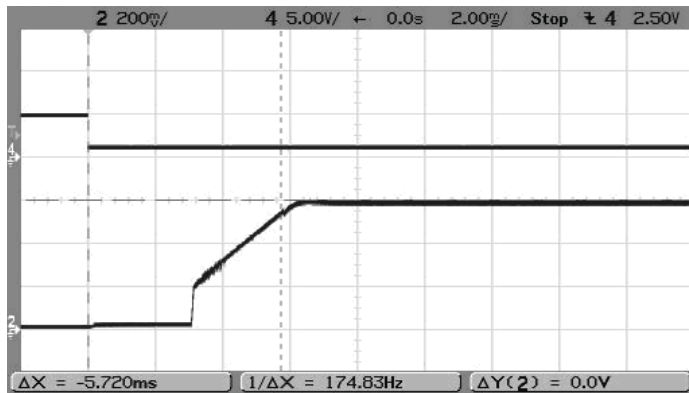

Output Ripple and Noise (Vin=12V, Vout=0.591V, Iout=3A, Cloud=0, ScopeBW=20MHz)

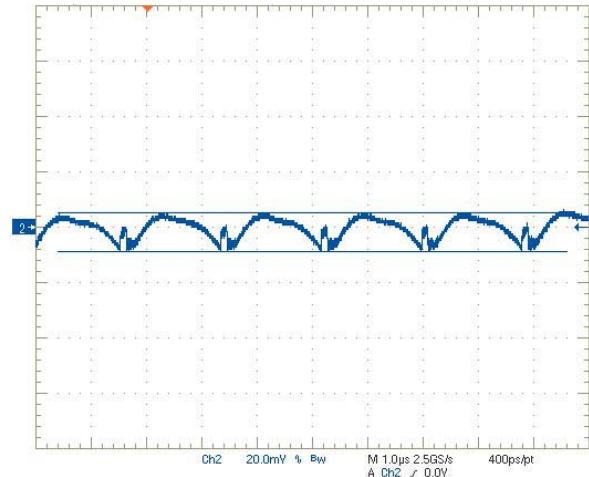

Step Load Transient Response (Vin=12V, Vout=0.591V, Cloud=0, Iout=1.5A to 3A)
Trace 2=Vout, 50 mV/div. Trace 4=Iout, 1A/div.

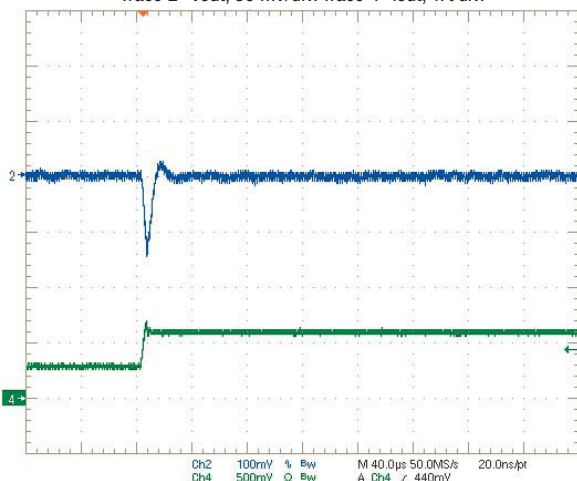

Step Load Transient Response (Vin=12V, Vout=0.591V, Cloud=0, Iout=3A to 1.5A)
Trace 2=Vout, 50 mV/div. Trace 4=Iout, 1A/div.

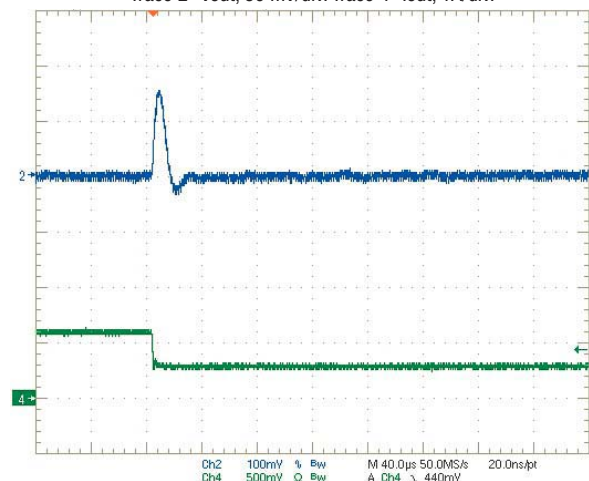

TAPE AND REEL INFORMATION

Tape Detail

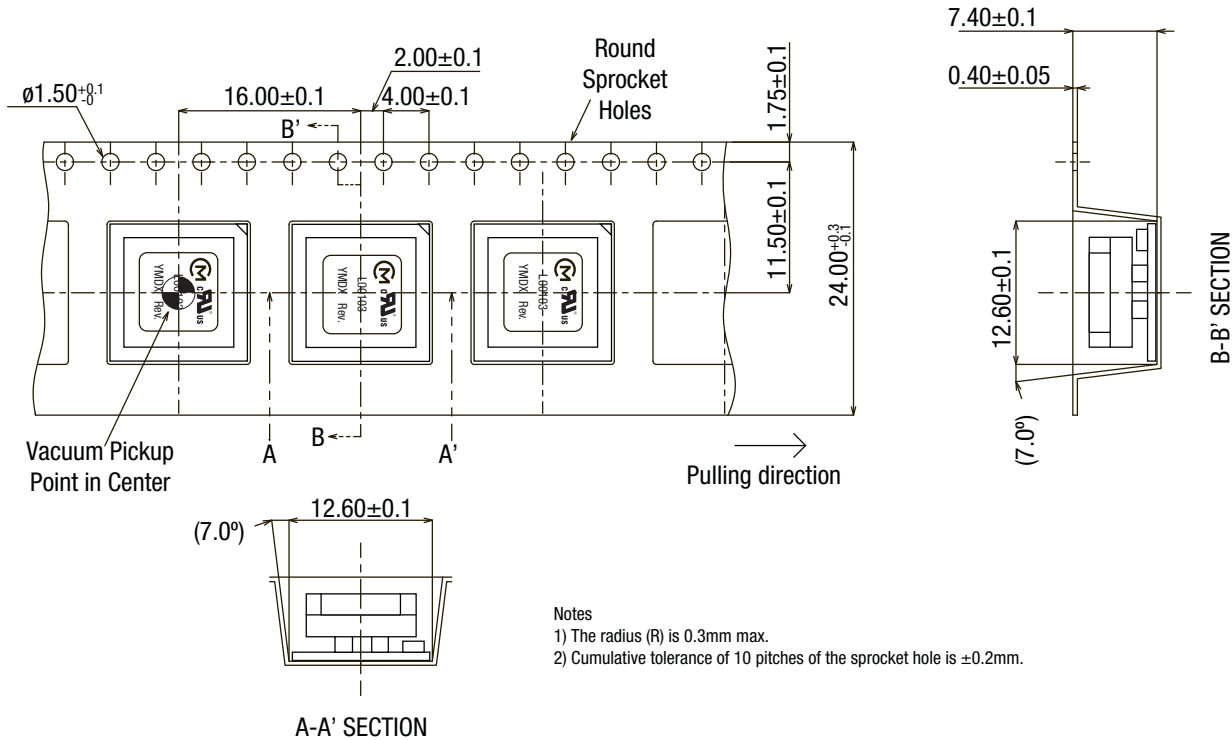

Reel Detail

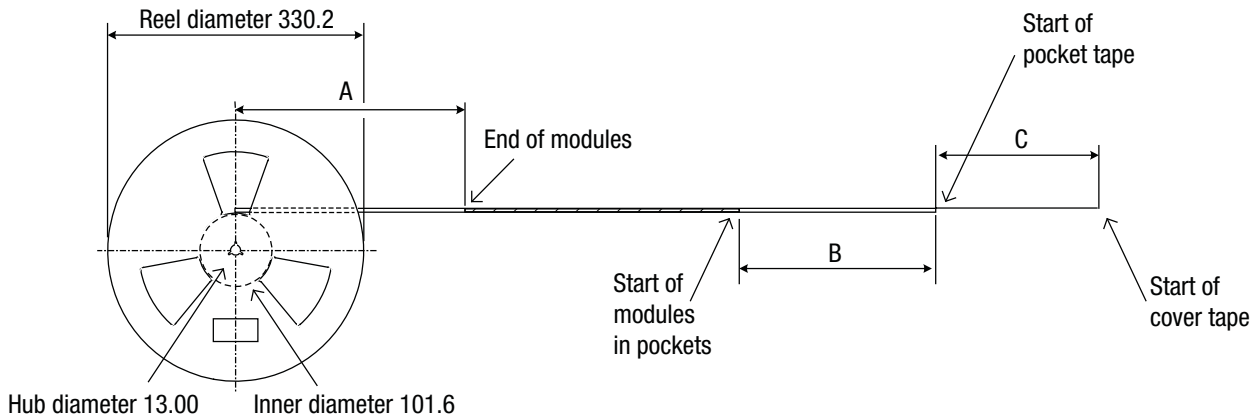

All dimensions are in millimeters.

Reel Information (400 units per reel)

Key	Description	Length (mm)
A	Tape trailer (no modules)	800 \pm 40
B	Pocket tape length before modules	200 min.
C	Cover tape length before pocket tape	240 \pm 40

