

KEMET Part Number: SSR10VS-13075
(UALR10VS130750)

KEMET, SSR10VS/HS, AC Line Filters, Common Mode, 7500 uH

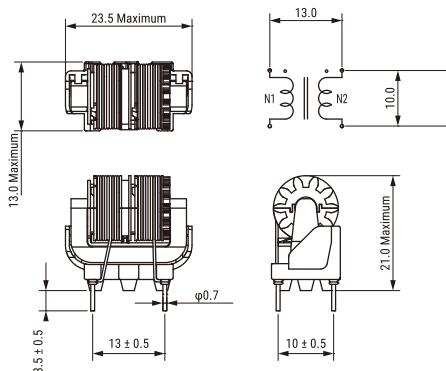

Dimensions

L	23.5mm MAX
T	13mm MAX
H	21mm MAX
LL	3.5mm +/-0.5mm
S	13mm +/-0.5mm

Packaging Specifications

Packaging:	Tray
Packaging Quantity:	600
Weight:	9 g

General Information

Series:	SSR10VS/HS
Style:	Through-Hole
Features:	Compact Size, Low Profile, Light Weight, High Frequency, Broad Bandwidth
RoHS:	Yes
Miscellaneous:	50 (K) Temperature Rise Max.

Specifications

Voltage AC:	250 VAC
Inductance:	7.5 mH (10 kHz)
Current:	1.3 A
Temperature Range:	-25/+120°C
DC Resistance:	240 mOhms