



Form 1+

Introducing
Desktop SLA.

formlabs 

Overview

With the Form 1+ you'll be printing in less than 15 minutes. It comes fully calibrated and ships with resin, software, finishing tools, and a one-year standard warranty—everything you need to succeed with 3D printing.

CONTENTS

- Technical Specifications . . . 2
- Exceptional Print Quality . . 3
- The Desktop Advantage . . 4
- Powerful Software 5
- Expert Customer Support . 6
- Additional Resources 6



Technical Specifications

THE FORM 1+

Price	€3399
Dimensions	30 × 28 × 45 cm / 12 × 11 × 18 in
Weight	8 kg / 18 lbs
Operating Temperature	18–28° C / 64–82° F
Power Requirements	100–240 V 1.5 A 50/60 Hz 60 W
Laser Specifications	EN 60825-1:2007 certified Class 1 Laser Product 405nm violet laser

PREFORM SOFTWARE

System Requirements	Windows XP (SP3) and up Mac OSX 10.6.8 and up
---------------------	--

PRINTING PROPERTIES

Technology	Stereolithography (SLA)
Build Volume	125 × 125 × 165 mm 4.9 × 4.9 × 6.5 in
Min Feature Size	300 microns 0.012 inches
Layer Thickness (Axis Resolution)	25, 50, or 100 microns 0.001, 0.002, or 0.004 inches
Supports	Auto-Generated. Easily Removable

FINISHING KIT

Includes	Finishing Tray, Scraper, Pre and Post-Rinse Tubs, Rinse Basket, Squeeze Bottle, Flush Cutters, Tweezers, Disposable Nitrile Gloves
----------	--

Exceptional Print Quality

The Form 1+ delivers professional-quality printed parts, at a fraction of the price.

HOBBYIST FDM¹

Part cost: €0.32
Machine cost: €1940



DESKTOP SLA (FORM 1+)^{1,2}

Part cost: €1.50
Machine cost: €3399



INDUSTRIAL SLA¹

Part cost: €4.66
Machine cost: €230000

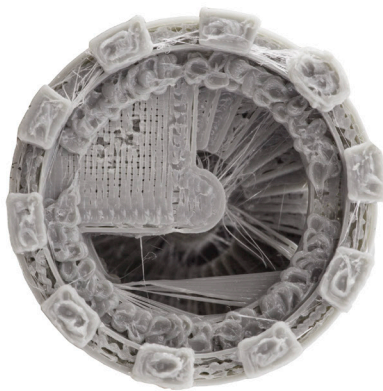

¹All parts printed at 100 micron layer height.

²Printed in Formlabs 'Grey Resin' — one of our Standard prototyping resins.

Standard Resins

Formulated in-house to deliver the highest-quality output, these resins capture astonishing detail without sacrificing durability or toughness.



HIGH-RESOLUTION

For demanding applications, our carefully-engineered resins capture the finest features in your model.

STRENGTH & PRECISION

Our resins create accurate and robust parts, ideal for rapid prototyping and product development.

SURFACE FINISH

Perfectly smooth right out of the printer, parts have the polish and finish of a final product.

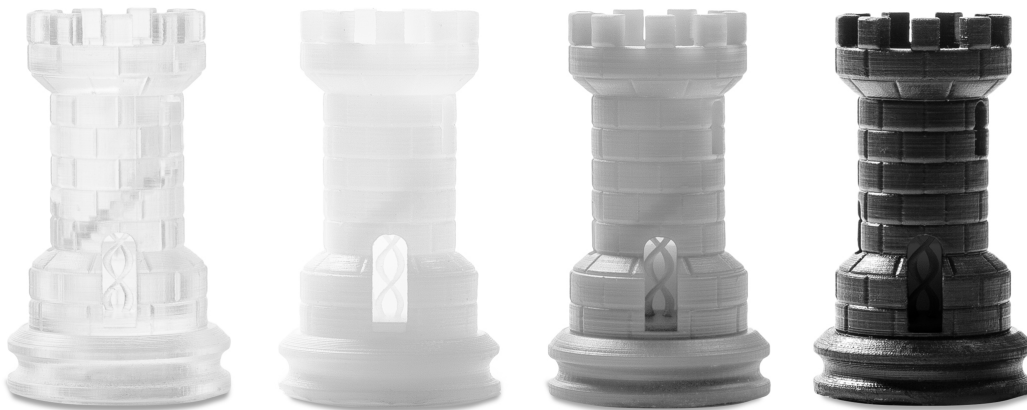

Resin Name	Price	Size	Applications
CLEAR	€135	1 Liter Bottle	Transparency, polishes to near optical clarity, great for internal channels and working with light.
WHITE	€135	1 Liter Bottle	Neutral tone, slight opacity when thin, provides a great base color for painting prints.
GREY	€135	1 Liter Bottle	Neutral tone, slight opacity when thin, great for showing off surface finish, photographs easily.
BLACK	€135	1 Liter Bottle	Highly pigmented, our most opaque, high detail resin, great for printing small, accurate features.

Clear Resin Technical Data Sheet¹

¹Material Properties are similar for White, Grey, and Black resins. For information on properties not listed, please [contact our sales team](#).

Functional Resins

Our growing library of high-performance resins adds new capabilities to the Form 1+ 3D printer, offering a range of material properties to explore.



CASTABLE RESIN

Castable burns out cleanly, without ash or residue and captures crisp, precise detail as well as extraordinarily smooth surfaces. It allows jewelers, designers, and engineers to go straight from a 3D design to a model suited for direct investment.

[Learn More](#)



FLEXIBLE RESIN

Flexible is versatile, tactile, and impact-resistant. Push the boundaries of 3D printing by creating parts that are bendable and compressible. Excellent for prototyping, product design, and engineering.

[Learn More](#)



Resin Name	Price	Size	Applications
CASTABLE	€135	500 mL Bottle	Investment casting, blue color, slightly softer than standard resins before post-curing.
FLEXIBLE	€90	500 mL Bottle	Impact resistance, compression, great for ergonomic soft-touch grips.

The Desktop Advantage

Nothing speeds the product development process as much as a printer on your desktop.

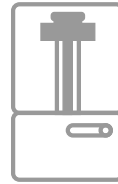
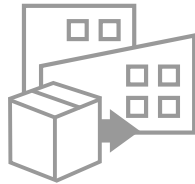

	SERVICE BUREAU	FORM 1+	INDUSTRIAL SLA
TURNAROUND TIME	1 – 2 weeks	< 24hrs	< 24hrs
UPFRONT COST	€0	€3399	€47000 – €230000
ROOK PRINT COST	€58.00	€1.50	€4.66
PRINT COST VS. FORM 1+	40x	1x	3x
LONG TERM COSTS	N/A	free one-year warranty	mandatory service contract (~€12000)
ACCESSIBILITY	external, third party	internal, desktop, anyone can use	internal, workshop, run by a technician, often projects will be billed for use

“...for our endoscopic version we had the initial design complete within 2 weeks and estimate a time saving of at least 6 months.”

– Alex Berry, Product Designer at Sutruie Ltd on switching from service bureaus.

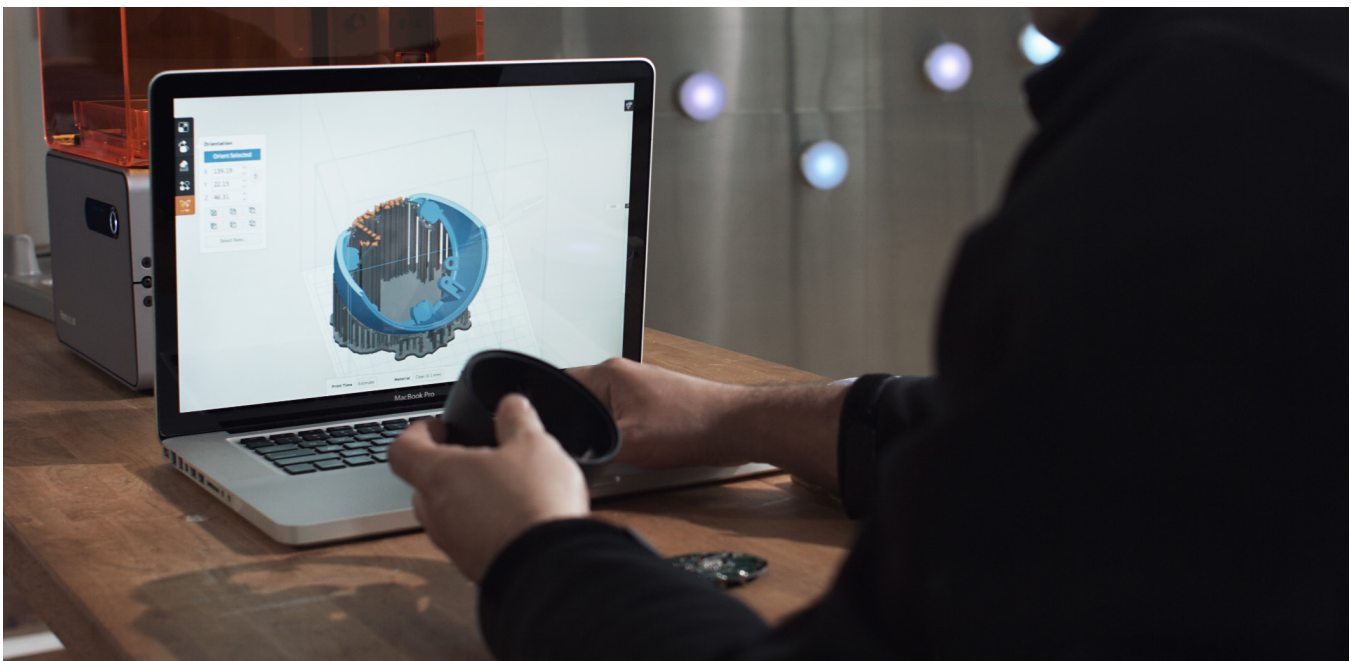

Powerful Software

PreForm (included) lets you print quickly, with its intuitive interface, useful tools, and regular updates.

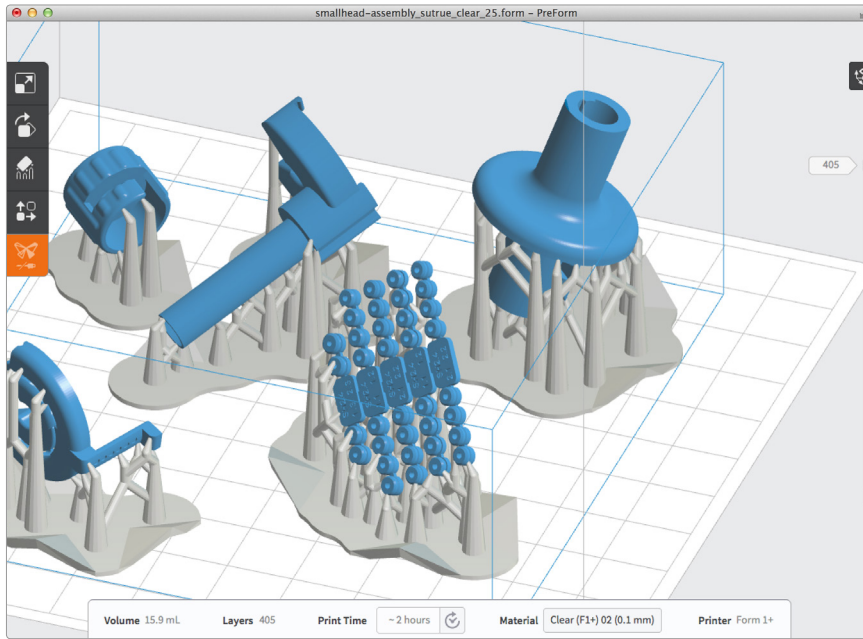

SIMPLE PROCESS

Automatic tools for orientation and support generation make print setup fast and effective.

ADVANCED FEATURES

Our advanced mode reveals complexity when you need it, allowing you to fine tune details like individual support placement, density, and geometry.

PRINT MANAGEMENT TOOLS

Print time and volume estimates help you calculate costs.

Download today for free at formlabs.com/products/preform

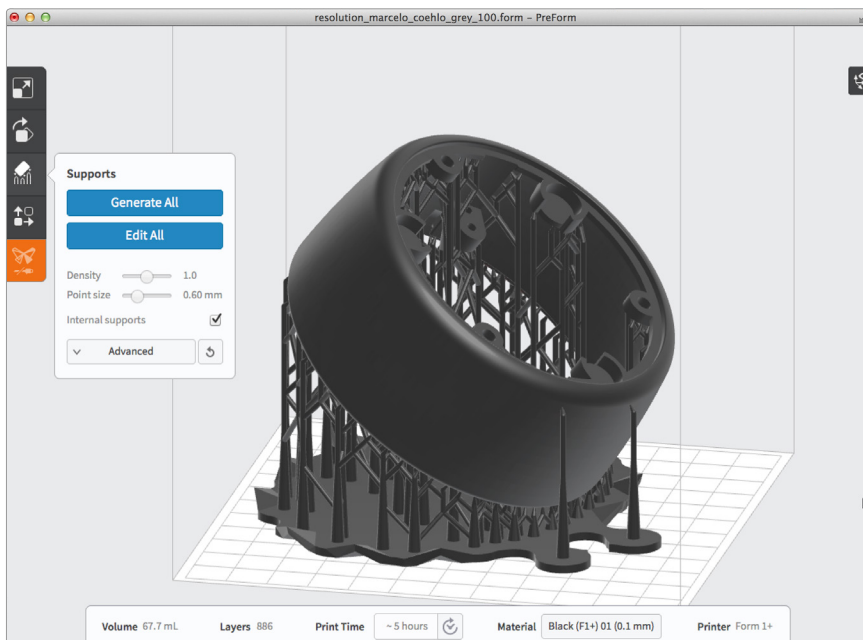

PREFORM SOFTWARE

System requirements

Windows XP (SP3) and up
Mac OSX 10.6.8 and up
OpenGL 2.1 support
2GB RAM

Features

Simple print setup
Auto-orient for optimal print position
Auto-mesh repair
Auto-generation of supports
Rotation, scaling, and duplication
Layer slicer for path inspection
.STL and .OBJ file input
.FORM file output

Expert Customer Support

Formlabs is an established leader in desktop 3D printing, with service centers in North America and the EU.



ONE YEAR WARRANTY

The Form 1+ ships with an industry-leading one-year standard warranty. No expensive service contracts. Just service you can trust.



CUSTOMER SUPPORT

Your Form 1+ comes with access to our experienced customer support engineers. Get the help and advice you need, fast.



SERVICING

If you run into problems, we'll make sure your printer is fixed quickly. We cover return shipping within our service regions too.



EDUCATIONAL RESOURCES

Our extensive online support site is filled with articles, videos, webinars and forums to provide help from the growing Formlabs community when you need it.

“What I’ve found is that, unlike other machines we’ve played with, the Form 1+ is a reliable beast.”

– Al Dean, *Develop3D.com*

“I’ve had some really bad experiences with support from companies, but Formlabs has consistently met or exceeded my expectations. Formlabs, thank you, *thank you*, for being such an amazing company to deal with.”

– Jared “-Tj-” Matsushige, *3D Artist, Hawaii*

Additional Resources

Helpful links

[Technical specs of material](#)

[Order the Form 1+ today](#)

[Order a sample part](#)

[Learn more at our support pages](#)

Contact

[Contact the sales team](#)

[Contact the support team](#)