

- > Ø 32 ... 320 mm
- > Comprehensive range for the utmost versatility
- > Conforms to ISO 15552 (ISO 6431, VDMA 24562 and NFE 49-003-1)
- > High performance, stability and reliability ideal for the demands of today
- > Supplied complete with piston rod locknut
- > Comprehensive range of standard mountings

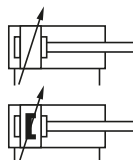

Technical features

Medium:

Compressed air, filtered, lubricated or non-lubricated

Standard:

ISO 15552

Operation:

RA/8000: Double acting, adjustable cushioning

RA/8000/M: Double acting, adjustable cushioning and magnetic piston

Operating pressure:

Ø 32 ... 200 mm
1 ... 16 bar (14 ... 232 psi)
Ø 250 & 320 mm
1 ... 10 bar (14 ... 145 psi)

Ports:

G1/8 ... G1

Cylinder diameters:

32, 40, 50, 63, 80, 100, 125, 160, 200, 250, 320 mm

Strokes:

See page below

Non-standard strokes:

Available (10 ... 3000 mm)

Operating temperature:

Ø 32 ... 125 mm
-20 ... +80°C max. (-4 ... +176 °F)
Ø 160 ... 320 mm
-10 ... +80°C max. (+14 ... +176°F)
Air supply must be dry enough to avoid ice formation at temperatures below +2°C (+35°F).

Materials:

Barrel: Anodised aluminium
End covers: Pressure diecast aluminium (Ø 200 ... 320 mm gravity cast aluminium)
Piston rod: Stainless steel (martensitic)
Piston rod seals: PUR (Ø 125 ... 320 mm NBR)
Piston seals: PUR (Ø 125 ... 320 mm NBR)
'O'-rings: NBR



Technical data

Cylinder Ø (mm)	32	40	50	63	80	100	125	160	200	250	320
Port size	G1/8	G1/4	G1/4	G3/8	G3/8	G1/2	G1/2	G3/4	G3/4	G1	G1
Piston rod Ø (mm)	12	16	20	20	25	25	32	40	40	50	63
Piston rod thread	M10 x 1,25	M12 x 1,25	M16 x 1,5	M16 x 1,5	M20 x 1,5	M20 x 1,5	M27 x 2	M36 x 2	M36 x 2	M42 x 2	M48 x 2
Cushion length mm	19	22	24	24	27	34	41	45	45	60	65
Initial cushion volume (cm ³)	12,3	20,7	36	64	116	242	451	816	1324	2900	5200
Theoretical thrusts at 6 bar outstroke (N)	482	754	1178	1870	3016	4710	7363	12064	18840	29436	48228
Theoretical thrusts at 6 bar instroke (N)	414	633	990	1680	2722	4416	6882	11310	18090	28236	47292
Air consumption at 6 bar outstroke (l/cm)	0,056	0,088	0,137	0,218	0,35	0,55	0,86	1,41	2,2	3,44	5,63
Air consumption at 6 bar instroke (l/cm)	0,048	0,074	0,114	0,195	0,32	0,51	0,79	1,32	2,1	3,3	5,41

Standard strokes

Cylinder Ø (mm)	Stroke length (mm)										
	25	50	80	100	125	160	200	250	320	400	500
32	•	•	•	•	•	•	•	•	•	•	•
40	•	•	•	•	•	•	•	•	•	•	•
50	•	•	•	•	•	•	•	•	•	•	•
63	•	•	•	•	•	•	•	•	•	•	•
80	•	•	•	•	•	•	•	•	•	•	•
100	•	•	•	•	•	•	•	•	•	•	•
125	•	•	•	•	•	•	•	•	•	•	•
160	•	•	•	•	•	•	•	•	•	•	•
200	•	•	•	•	•	•	•	•	•	•	•
250	•	•	•	•	•	•	•	•	•	•	•
320	•	•	•	•	•	•	•	•	•	•	•

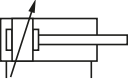
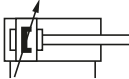
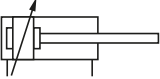
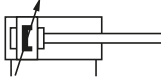
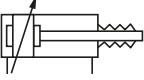
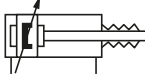
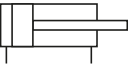
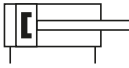
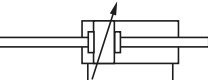
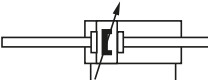
Cylinder variants

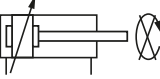
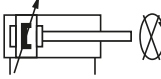
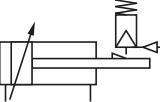
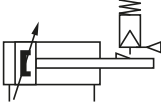
Symbol	Model Non-magnetic piston				Symbol	Model magnetic piston				Description	Dimensions Page		
	H	T	C	S		H	T	C	S				
	•	•	•	•	RA/8000		•	•	•	•	RA/8000/M	Standard cylinder	6
					•		•	RA/8000/W1	Cylinder with special wiper/seal (suitable for appl. with cement, plaster (stucco), arizona sand, hoar-frost or ice (Ø 32 ... 125 mm))	6			
			•	•	RA/8000/X1				•	•	RA/8000/X2	Low friction cylinders, operating pressure: 1 ... 10 bar Medium: Compressed air, filtered and non-lubricated recommended (Ø 32 ... 200 mm)	6
	•	•	•	•	RA/8000/IU		•	•	•	•	RA/8000/MU	Cylinder with extended piston rod	6
				•	•		RA/8000/W5			•	•	RA/8000/W6	Cylinder with extended piston rod and special wiper/seal (suitable for applications with cement, plaster (stucco), arizona sand, hoar-frost or ice (Ø 32 ... 125 mm))
			•	•	RA/8000/G		•	•	•	RA/8000/MG	Cylinder with piston rod bellows	8	
			•	•	RA/8000/W				•	•	RA/8000/MW	Cylinder without cushioning	7
				•	•		RA/8000/X3			•	•	RA/8000/X4	Low friction cylinders without cushioning, operating pressure: 1 ... 10 bar Medium: Compressed air, filtered and non-lubricated recommended (Ø 32 ... 200 mm)
	•	•	•	•	RA/8000/J		•	•	•	•	RA/8000/JM	Cylinder with double ended piston rod	7
				•	•		RA/8000/W3			•	•	RA/8000/W4	Cylinder with double ended piston rod and special wiper/seal (suitable for applications with cement, plaster (stucco), arizona sand, hoar-frost or ice (Ø 32 ... 125 mm))
			•	•	RA/8000/IT				•	•	RA/8000/MT	Four position cylinders (Ø 32 ... 200 mm)	7
					RA/8000/N1						RA/8000/N2	Cylinder with non-rotating piston rod, (Ø 32 ... 100 mm)	6
			•	•	RA/8000/L2				•	•	RA/8000/L4	Cylinder with locking unit (passive) spring force on removal of the signal to the unit. Operating pressure for locking unit: 4 ... 10 bar (Ø 32 ... 125 mm)	9

For the cylinder models style H*1), T, C and S see options selector

*1) Cylinder style H (Hydraulic version): Ø 32 ... 100 mm only

Option selector

Non-standard variants	Substitute
High temperature version 150°C max.	T
Hydraulic version ø 32 ... 100 mm only	H
Piston rod material	Substitute
Stainless steel martensitic	R
Hard chromium plated	C
Stainless steel austenitic	S
Cylinder Ø	Substitute
032, 040, 050, 063, 080, 100, 125, 160, 200, 250, 320	
Variants (magnetic piston)	Substitute
Standard	M
Special wiper/seal	W2
Low friction	X2
Piston rod bellow	MG
Without cushion	MW
Without cushion, low friction	X4
Double ended piston rod	JM
Double ended piston rod special wiper/seal	W4
Four-positon cylinder	MT
Non-rotating piston rod (internal)	N2
Locking unit (passive)	L4
Extended piston rod	MU
Extended piston rod, special wiper/seal	W6
A/8* /MU/****/**** /W6/	Extension (mm)

*****A/8*** / ** / ** / ** / ****







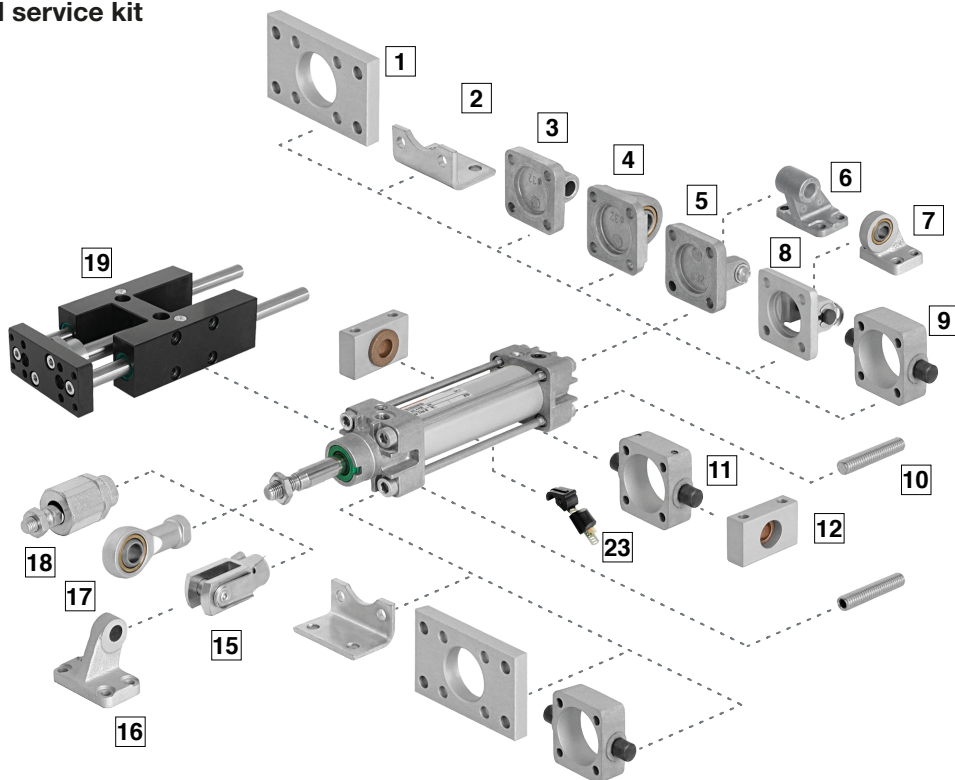

Strokes (mm)	Substitute
3000 max.	
Variants (non-magnetic piston)	Substitute
Standard	None
Special wiper/seal	W1
Low friction	X1
Piston rod bellow	G
Without cushion	W
Without cushion, low friction	X3
Double ended piston rod	J
Double ended piston rod special wiper/seal	W3
Four-positon cylinder	IT
Non-rotating piston rod (internal)	N1
Locking unit (passive)	L2
Extended piston rod	IU
Extended piston rod special wiper/seal P**/182*** /IU/****/**** /W5/	W5
	Extension (mm)

Note: If option is not required, disregard option position within part number eg. RA/8100/M/100.
For combinations of cylinder variants consult our technical service. Please note that heat resistant seals are not available for all variants. This options selector explains only the cylinder variants.
Additional variants/options are not possible.

Mountings and service kit



Mountings

Model	A	AK	B, G	C	D	D2	F	FH	H
									
Cyl. Ø	10	18	1	2	5	8	15	9	11
	Page 10	Page 10	Page 10	Page 10	Page 11	Page 11	Page 11	Page 11	Page 12
32	QM/8032/35	QM/8025/38	QA/8032/22	QA/8032/21	QA/8032/23	QA/8032/42	QM/8025/25	QA/8032/34	QA/8032/28
40	QM/8032/35	QM/8040/38	QA/8040/22	QA/8040/21	QA/8040/23	QA/8040/42	QM/8040/25	QA/8040/34	QA/8040/28
50	QM/8050/35	QM/8050/38	QA/8050/22	QA/8050/21	QA/8050/23	QA/8050/42	QM/8050/25	QA/8050/34	QA/8050/28
63	QM/8050/35	QM/8050/38	QA/8063/22	QA/8063/21	QA/8063/23	QA/8063/42	QM/8050/25	QA/8063/34	QA/8063/28
80	QM/8080/35	QM/8080/38	QA/8080/22	QA/8080/21	QA/8080/23	QA/8080/42	QM/8080/25	QA/8080/34	QA/8080/28
100	QM/8080/35	QM/8080/38	QA/8100/22	QA/8100/21	QA/8100/23	QA/8100/42	QM/8080/25	QA/8100/34	QA/8100/28
125	QM/8125/35	QM/8125/38	QM/8125/22	QM/8125/21	QM/8125/23	QA/8125/42	QM/8125/25	QA/8125/34	QM/8125/28
160	QM/8160/35	QM/8160/38	QM/8160/22	QM/8160/21	QM/8160/23	QA/8160/42	QM/8160/25	—	QM/8160/28
200	QM/8160/35	QM/8160/38	QM/8200/22	QM/8200/21	QM/8200/23	QA/8200/42	QM/8160/25	—	QM/8200/28
250	QM/8250/35	—	QM/8250/22	QM/8250/21	QM/8250/23	—	QM/8250/25	—	QM/8250/28
320	QM/8320/35	—	QM/8320/22	QM/8320/21	QM/8320/23	—	QM/8320/25	—	QM/8320/28

Mountings

	R	S	SS	SW	UF	UH	UR	US
	3	12	16	6	17	11	4	7
	Page 12	Page 12	Page 14	Page 13	Page 13	Page 12	Page 13	Page 14
Cyl. Ø	QA/8032/27	QA/8032/41	M/P19931	M/P19493	QM/8025/32	PQA/182032/40	QA/8032/33	M/P40310
32	QA/8040/27	QA/8040/41	M/P19932	M/P19494	QM/8040/32	PQA/182040/40	QA/8040/33	M/P40311
40	QA/8050/27	QA/8040/41	M/P19933	M/P19495	QM/8050/32	PQA/182050/40	QA/8050/33	M/P40312
50	QA/8063/27	QA/8063/41	M/P19934	M/P19496	QM/8050/32	PQA/182063/40	QA/8063/33	M/P40313
63	QA/8080/27	QA/8063/41	M/P19935	M/P19497	QM/8080/32	PQA/182080/40	QA/8080/33	M/P40314
80	QA/8100/27	QA/8100/41	M/P19936	M/P19498	QM/8080/32	PQA/182100/40	QA/8100/33	M/P40315
100	QM/8125/27	QA/8100/41	M/P19937	M/P19499	QM/8125/32	PQA/182125/40	QM/8125/33	M/P71355
125	QM/8160/27	QA/8160/41	M/P19938	M/P19679	QM/8160/32	QM/8160/40	QM/8160/33	M/P71356
160	QM/8200/27	QA/8160/41	M/P19939	M/P19683	QM/8160/32	QM/8200/40	QM/8200/33	M/P71357
200	—	—	—	M/P19446	QM/8250/32	—	QM/8250/33	—
250	—	—	—	M/P19447	QM/8320/32	—	QM/8320/33	—
320	—	—	—	—	—	—	—	—

Guide blocks

	Guide blocks - plain bearings	Guide blocks - roller bearings	Guide blocks - plain bearings, long coupling	Guide blocks - plain bearings, short coupling
	19	19	19	19
	Page 15	Page 16	Page 18	Page 18
Cyl. Ø	QA/8032/51/*	QA/8032/61/*	QA/8032/81/*	QA/8032/85/*
32	QA/8040/51/*	QA/8040/61/*	QA/8040/81/*	QA/8040/85/*
40	QA/8050/51/*	QA/8050/61/*	QA/8050/81/*	QA/8050/85/*
50	QA/8063/51/*	QA/8063/61/*	QA/8063/81/*	QA/8063/85/*
63	QA/8080/51/*	QA/8080/61/*	QA/8080/81/*	QA/8080/85/*
80	QA/8100/51/*	QA/8100/61/*	QA/8100/81/*	QA/8100/85/*
100	—	—	—	—

* Insert standard stroke length: 50, 100, 160, 200, 250, 320, 400 and 500 mm, use nearest standard stroke.

Accessories

Magnetically operated switches

	M/50/**	Switch mounting brackets for M/50	TQM/31, QM/32, QM/132	Switch mounting brackets for TQM/31, QM/32, QM/132	QM/140	Switch mounting brackets for QM/140
		23				
	Page 20 & 21	Page 21	Page 22	Page 22	Page 23	Page 23
Cyl. Ø	QM/27/2/1	QM/27/2/1	QM/31/032/22	QM/31/032/22	QM/140/010/22	QM/140/010/22
32	QM/27/2/1	QM/27/2/1	QM/31/032/22	QM/31/032/22	QM/1w40/010/22	QM/140/010/22
40	QM/27/2/1	QM/27/2/1	QM/31/032/22	QM/31/032/22	QM/140/010/22	QM/140/010/22
50	QM/27/2/1	QM/27/2/1	QM/31/080/22	QM/31/080/22	QM/140/010/22	QM/140/010/22
63	QM/27/2/1	QM/27/2/1	QM/31/080/22	QM/31/080/22	—	—
80	QM/27/2/1	QM/27/2/1	QM/31/160/22	QM/31/160/22	—	—
100	QM/27/2/1	QM/27/2/1	QM/31/160/22	QM/31/160/22	—	—
125	—	—	QM/31/250/22	QM/31/250/22	—	—
160	—	—	QM/31/320/22	QM/31/320/22	—	—
200	—	—	—	—	—	—
250	—	—	—	—	—	—
320	—	—	—	—	—	—



Service kit

	Service kit
Cyl. Ø	QA/8032/00
32	QA/8040/00
40	QA/8050/00
50	QA/8063/00
63	QA/8080/00
80	QA/8100/00
100	QA/8125/00
125	QA/8160/00
160	QA/8200/00
200	QA/8250/00
250	QA/8320/00
320	—

Basic dimensions
RA/8000; RA/8000/M

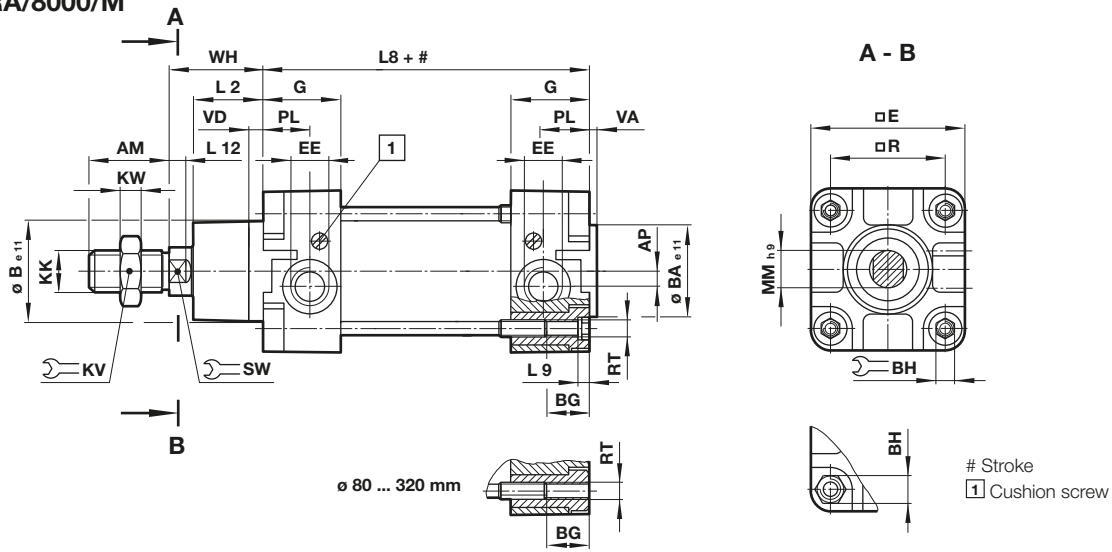
Dimensions in mm
Projection/First angle



Ø	AM	AP	Ø B e11	Ø BA e11	BG		□ E	EE	G	KK		KW	L2	L8	L9
32	22	3,5	30	30	18	6	47	G 1/8	27,5	M10x1,25	17	5	20	94	4
40	24	4,5	35	35	18	6	53	G 1/4	32	M12x1,25	19	6	22	105	4
50	32	6	40	40	18	8	65	G 1/4	31	M16x1,5	24	8	27	106	5
63	32	10	45	45	17,5	8	75	G 3/8	33	M16x1,5	24	8	29	121	5
80	40	8,5	45	45	21,5	19	95	G 3/8	33	M20x1,5	30	10	33	128	-
100	40	9	55	55	21,5	19	115	G 1/2	37	M20x1,5	30	10	36	138	-
125	54	10	60	60	30	24	140	G 1/2	46	M27x2	41	13,5	45	160	-
160	72	19	65	65	28,5	32	183,5	G 3/4	50	M36x2	55	18	58	180	-
200	72	19	75	75	28,5	32	224	G 3/4	50	M36x2	55	18	67	180	-
250	84	22	90	90	35	36	280	G 1	58	M42x2	65	21	80	200	-
320	96	22	110	110	30	46	350	G 1	60	M48x2	75	24	90	220	-
Ø	L12	Ø MM h9	PL	□ R	RT		VA	VD	WH	at 0 mm	per 25 mm	Model non-magnetic piston	Model magnetic piston		
32	6	12	13	32,5	M 6	10	3	6	26	0,51 kg	0,06 kg	RA/8032/*	RA/8032/M/*		
40	6,5	16	15	38	M 6	13	3,5	6	30	0,80 kg	0,08 kg	RA/8040/*	RA/8040/M/*		
50	8	20	18,5	46,5	M 8	17	3,5	6	37	1,33 kg	0,12 kg	RA/8050/*	RA/8050/M/*		
63	8	20	19	56,5	M 8	17	4	6	37	1,80 kg	0,13 kg	RA/8063/*	RA/8063/M/*		
80	10	25	19	72	M 10	22	4	6	46	3,25 kg	0,20 kg	RA/8080/*	RA/8080/M/*		
100	10	25	18	89	M 10	22	4	6	51	4,81 kg	0,23 kg	RA/8100/*	RA/8100/M/*		
125	13	32	22,5	110	M 12	27	6	15,5	65	8,00 kg	0,33 kg	RA/8125/*	RA/8125/M/*		
160	16	40	25	140	M 16	36	4	15	80	14,9 kg	0,55 kg	RA/8160/*	RA/8160/M/*		
200	16	40	26	175	M 16	36	5	15	95	21,7 kg	0,60 kg	RA/8200/*	RA/8200/M/*		
250	20	50	28	220	M 20	41	7	13	105	32,6 kg	0,92 kg	RA/8250/*	RA/8250/M/*		
320	24	63	31	270	M 24	55	7	13	120	59,8 kg	1,46 kg	RA/8320/*	RA/8320/M/*		

* Please insert standard stroke length.

Cylinder variants
RA/8000/N1, RA/8000/N2 – Cylinder with non-rotating piston rod

Ø		max. Torque (Nm)	Model non-magnetic piston	Model magnetic piston
32	10	0,5	RA/8032/N1/*	RA/8032/N2/*
40	13	1	RA/8040/N1/*	RA/8040/N2/*
50	16	1,5	RA/8050/N1/*	RA/8050/N2/*
63	16	1,5	RA/8063/N1/*	RA/8063/N2/*
80	16	2,5	RA/8080/N1/*	RA/8080/N2/*
100	21	2,5	RA/8100/N1/*	RA/8100/N2/*

* Please insert standard stroke length.

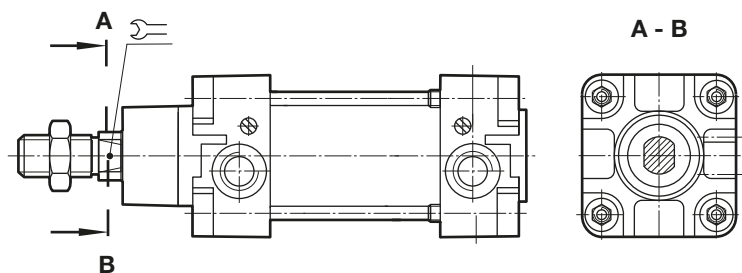

Cylinder variants
RA/8000/J, RA/8000/JM – Cylinder with double ended piston rod

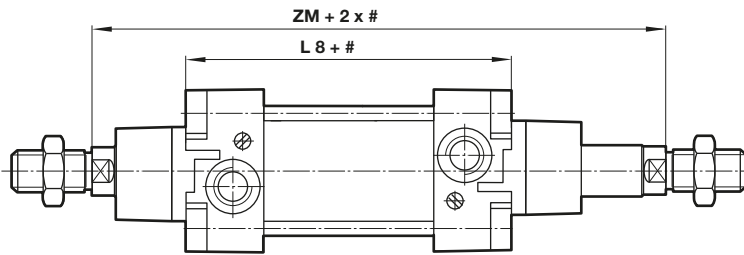
 Dimensions in mm
Projection/First angle

Stroke

Ø	ZM	L8	Model non-magnetic piston	Model magnetic piston
32	146	94	RA/8032/J/*	RA/8032/JM/*
40	165	105	RA/8040/J/*	RA/8040/JM/*
50	180	106	RA/8050/J/*	RA/8050/JM/*
63	195	121	RA/8063/J/*	RA/8063/JM/*
80	220	128	RA/8080/J/*	RA/8080/JM/*
100	240	138	RA/8100/J/*	RA/8100/JM/*
125	290	160	RA/8125/J/*	RA/8125/JM/*
160	340	180	RA/8160/J/*	RA/8160/JM/*
200	370	180	RA/8200/J/*	RA/8200/JM/*
250	410	200	RA/8250/J/*	RA/8250/JM/*
320	460	220	RA/8320/J/*	RA/8320/JM/*

* Please insert standard stroke length.

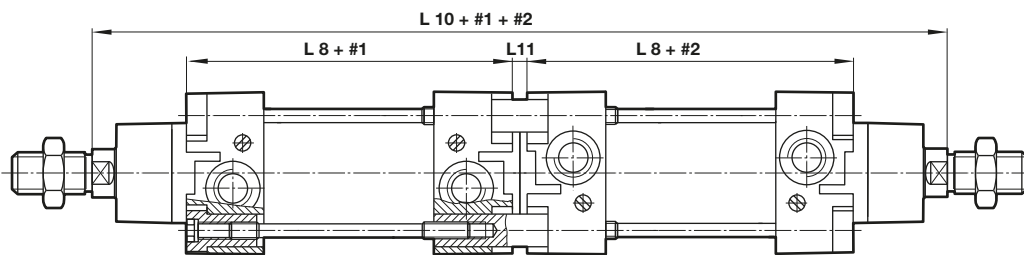
RA/8000/IT, RA/8000/MT – Four-position cylinder

Stroke

Ø	L 8	L 10	L 11	Model non-magnetic piston	Model magnetic piston
32	94	247	7	RA/8032/IT/***	RA/8032/MT/***
40	105	278	8	RA/8040/IT/***	RA/8040/MT/***
50	106	294	8	RA/8050/IT/***	RA/8050/MT/***
63	121	325	9	RA/8063/IT/***	RA/8063/MT/***
80	128	357	9	RA/8080/IT/***	RA/8080/MT/***
100	138	387	9	RA/8100/IT/***	RA/8100/MT/***
125	160	462	12	RA/8125/IT/***	RA/8125/MT/***
160	180	532	12	RA/8160/IT/***	RA/8160/MT/***
200	180	560	10	RA/8200/IT/***	RA/8200/MT/***

* Please insert standard stroke length 1

** Please insert standard stroke length 2

RA/8000/G, RA/8000/MG – Piston rod bellow

Dimensions in mm
Projection/First angle

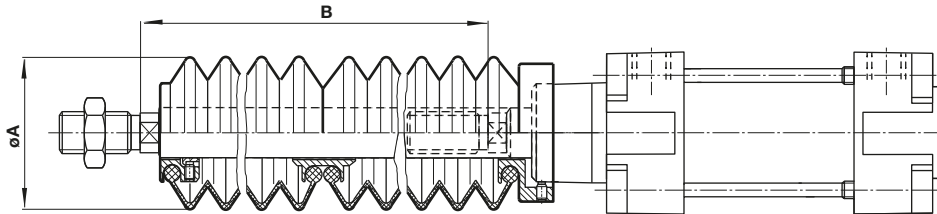

\varnothing	$\varnothing A$	Max. stroke per bellow	Piston rod extension B		Model non-magnetic piston	Model magnetic piston
			for first bellow	for further bellow		
32	40	60	30	25	RA/8032/G/*	RA/8032/MG/*
40	63	145	50	32	RA/8040/G/*	RA/8040/MG/*
50	63	145	40	32	RA/8050/G/*	RA/8050/MG/*
63	63	145	40	32	RA/8063/G/*	RA/8063/MG/*
80	80	250	50	45	RA/8080/G/*	RA/8080/MG/*
100	80	250	50	45	RA/8100/G/*	RA/8100/MG/*
125	80	250	50	45	RA/8125/G/*	RA/8125/MG/*
160	116	350	70	60	RA/8160/G/*	RA/8160/MG/*
200	116	350	70	60	RA/8200/G/*	RA/8200/MG/*
250	116	350	70	60	RA/8250/G/*	RA/8250/MG/*
320	143	500	110	100	RA/8320/G/*	RA/8320/MG/*

* Please insert standard stroke length.

RA/8000/L2, RA/8000/L4 – Cylinder with locking unit (passive)

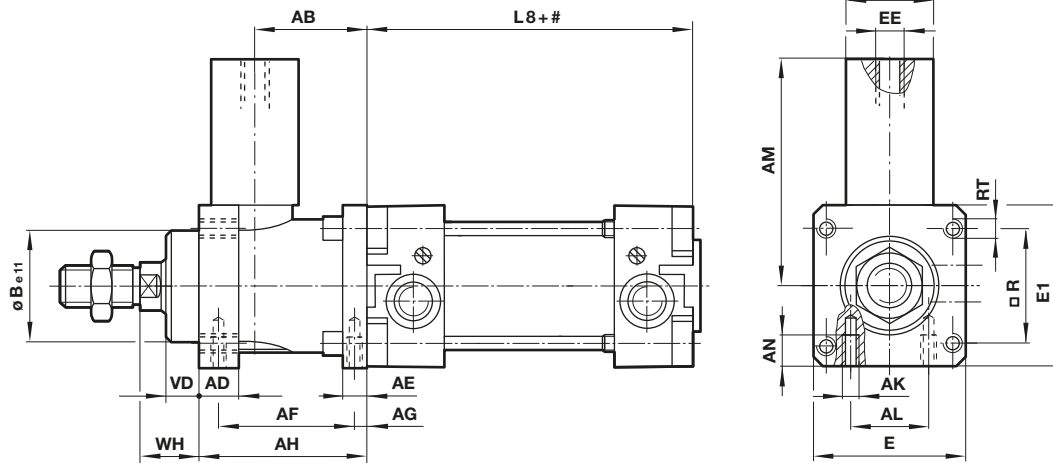
 Dimensions in mm
Projection/First angle

Stroke

Ø	AB	AD	AE	AF	AG	AH	Ø AJ	AK	AL	AM	AN	Ø B e11	E	E 1	EE
32	32	12	8	40	4,2	48	25	M 5	16	59	8	30	48	50	M 5
40	35,5	12	10	46	4,5	55	24	M 5	21	61,5	10	35	56	58	G 1/8
50	49	16	15	54	11,5	70	30	M 6	24	75	12	40	68	70	G 1/8
63	49	15	15	55	7,5	70	38	M 8	32	86	12	45	82	85	G 1/8
80	62	16	16	70	10	90	53	M 8	44	119	16	45	100	105	G 1/8
100	65	18	16	70	10	92	48	M 8	60	119	16	55	120	130	G 1/8
125	85	27	25	95	11	122	65	M 10	75	140	20	60	140	150	G 1/8
Ø	L 8	□ R	RT	VD	WH	Locking force (N)	Spare part Locking unit *1)		Spare part Cartridge	Model Non-magnetic piston	Model Magnetic piston				
32	94	32,5	M 6	10	16	600	QA/8032/59		QA/8032/63	RA/8032/L2/*	RA/8032/L4/*				
40	105	38	M 6	10	18	1000	QA/8040/59		QA/8040/63	RA/8040/L2/*	RA/8040/L4/*				
50	106	46,5	M 8	12	22	1500	QA/8050/59		QA/8050/63	RA/8050/L2/*	RA/8050/L4/*				
63	121	56,5	M 8	12	20	2200	QA/8063/59		QA/8063/63	RA/8063/L2/*	RA/8063/L4/*				
80	128	72	M 10	20	33	5000	QA/8080/59		QA/8100/63	RA/8080/L2/*	RA/8080/L4/*				
100	138	89	M 10	23	38	5000	QA/8100/59		QA/8100/63	RA/8100/L2/*	RA/8100/L4/*				
125	160	110	M 12	32	65	7000	QA/8125/59		QA/8125/63	RA/8125/L2/*	RA/8125/L4/*				

* Please insert standard stroke length.

*1) With cartridge

Mountings

Front or rear stud mounting A

Conforms to ISO 15552, type MX1

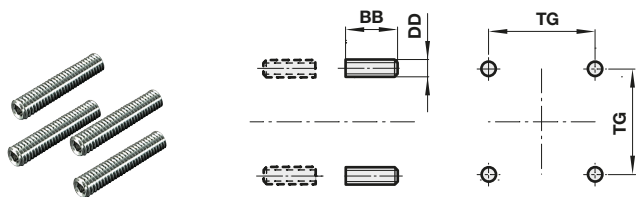

Ø	BB	DD	TG	kg	Model (A)
32/40	17	M6	32,5/38	0,02	QM/8032/35
50/63	23	M8	46,5/56,5	0,05	QM/8050/35
80/100	28	M10	72/89	0,08	QM/8080/35
125	34	M12	110	0,14	QM/8125/35
160/200	42	M16	140/175	0,31	QM/8160/35
250	50	M20	220	0,92	QM/8250/35
320	60	M24	270	1,46	QM/8320/35

Front flange B, G

Conforms to ISO 15552, type MF1 and MF2

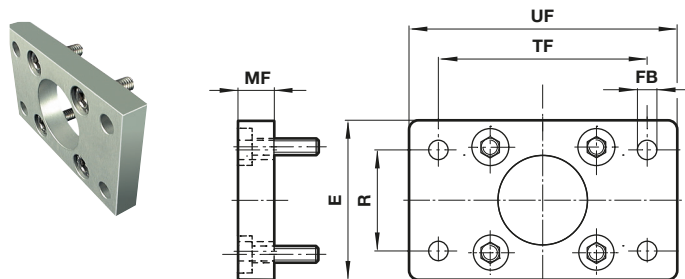

Ø	E	Ø FB	MF	R	TF	UF	kg	Model (B, G)
32	50	7	10	32	64	80	0,25	QA/8032/22
40	55	9	10	36	72	90	0,35	QA/8040/22
50	65	9	12	45	90	110	0,70	QA/8050/22
63	75	9	12	50	100	125	0,80	QA/8063/22
80	100	12	16	63	126	154	1,35	QA/8080/22
100	120	14	16	75	150	186	2,20	QA/8100/22
125	140	16	20	90	180	224	2,70	QM/8125/22
160	180	18	20	115	230	280	3,1	QM/8160/22
200	220	22	25	135	270	320	4,6	QM/8200/22
250	280	26	25	165	330	395	7,4	QM/8250/22
320	350	33	30	200	400	475	13,6	QM/8320/22

Piston rod swivel AK

Dimensions in mm
Projection/First angle

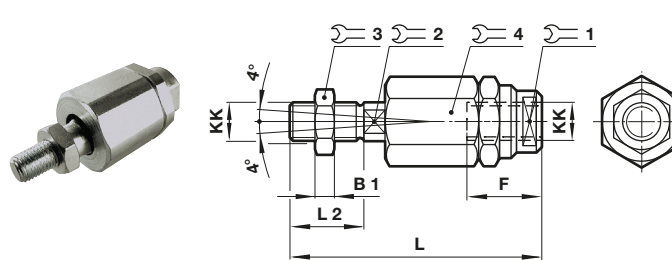

Ø	KK	B1	F	L	L2	1	2	3	4	kg	Model (AK)
32	M10x1,25	5	26	73	20	19	12	17	30	0,20	QM/8025/38
40	M12x1,25	6	26	77	24	19	12	19	30	0,20	QM/8040/38
50/63	M16x1,5	8	34	106	32	30	19	24	42	0,65	QM/8050/38
80/100	M20x1,5	10	42	122	40	30	19	30	42	0,72	QM/8080/38
125	M27x2	13,5	40	147	54	40	24	41	55	1,70	QM/8125/38
160/200	M36x2	18	78	251	72	50	36	55	75	5,4	QM/8160/38

Foot mounting C

Conforms to ISO 15552, type MS1

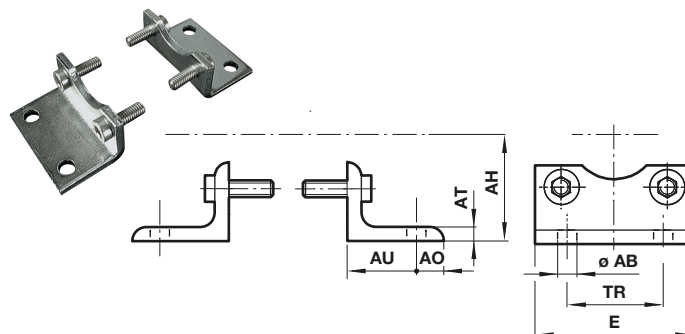

Ø	Ø AB	AH	AO	AT	AU	E	TR	kg	Model (C)
32	7	32	8	4	24	48	32	0,15	QA/8032/21
40	10	36	9	4	28	53	36	0,18	QA/8040/21
50	10	45	10	5	32	64	45	0,30	QA/8050/21
63	10	50	12	5	32	74	50	0,39	QA/8063/21
80	12	63	19	5	41	98	63	0,80	QA/8080/21
100	14	71	19	5	41	115	75	0,95	QA/8100/21
125	16	90	20	9	45	140	90	2,40	QM/8125/21
160	18	115	20	8	60	180	115	3,5	QM/8160/21
200	22	135	30	9	70	220	135	5,25	QM/8200/21
250	26	165	35	10	75	280	165	9,5	QM/8250/21
320	33	200	45	16	85	350	200	22	QM/8320/21

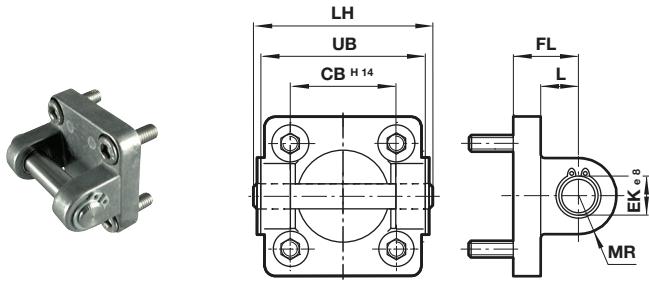
**Rear clevis D
Conforms to ISO 15552, type MP2**

Ø	CB H14	Ø EK e8	FL	L	LH	MR	UB	kg	Model (D)
32	26	10	22	13	52	9	45	0,11	QA/8032/23
40	28	12	25	16	60	12	52	0,16	QA/8040/23
50	32	12	27	17	68	12	60	0,22	QA/8050/23
63	40	16	32	22	79	15	70	0,34	QA/8063/23
80	50	16	36	22	99	15	90	0,54	QA/8080/23
100	60	20	41	27	119	20	110	0,90	QA/8100/23
125	70	25	50	31	139	25	130	2,70	QM/8125/23
160	90	30	55	35,5	181	30	170	4,3	QM/8160/23
200	90	30	60	36	181	30	170	6,1	QM/8200/23
250	110	40	70	45	218	40	200	19	QM/8250/23
320	120	45	80	50	238	45	220	30,5	QM/8320/23

**Rear clevis D2
Conforms to ISO 15552, type AB6**

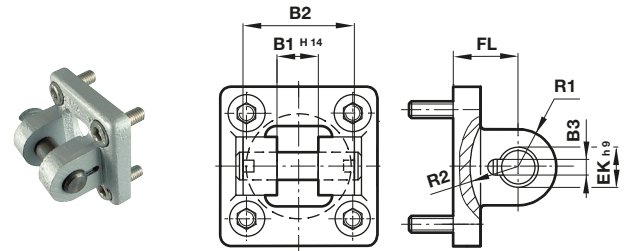
 Dimensions in mm
Projection/First angle

Ø	B1 H14	B2	B3	Ø EK h9	FL	R1	R2	kg	Model (D2)
32	14	34	3,3	10	22	11	17	0,20	QA/8032/42
40	16	40	4,3	12	25	12	20	0,23	QA/8040/42
50	21	45	4,3	16	27	14,5	22	0,36	QA/8050/42
63	21	51	4,3	16	32	18	25	0,55	QA/8063/42
80	25	65	4,3	20	36	22	30	0,90	QA/8080/42
100	25	75	4,3	20	41	22	32	1,45	QA/8100/42
125	37	97	6,3	30	50	30	42	2,7	QA/8125/42
160	43	122	6,3	35	55	36	46	4,3	QA/8160/42
200	43	122	6,3	35	60	38	49	6,1	QA/8200/42

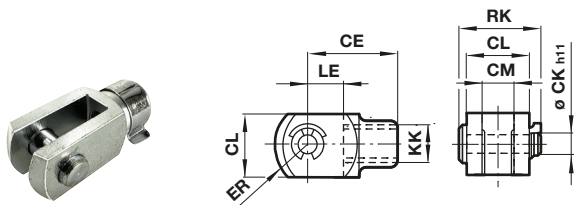
**Piston rod clevis F
Conforms to DIN ISO 8140**

Ø	KK	CE	Ø CK h11	CL	CM	ER	LE	RK	kg	Model (F)
32	M10x1,25	40	10	20	10	16	20	28	0,09	QM/8025/25
40	M12x1,25	48	12	24	12	19	24	32	0,13	QM/8040/25
50/63	M16x1,5	64	16	32	16	25	32	41,5	0,33	QM/8050/25
80/100	M20x1,5	80	20	40	20	32	40	50	0,67	QM/8080/25
125	M27x2	110	30	55	30	45	54	62	1,35	QM/8125/25
160/200	M36x2	144	35	70	35	57	72	95	3	QM/8160/25
250	M42x2	168	40	85	40	68	84	106	6,4	QM/8250/25
320	M48x2	192	50	96	50	85	96	121	8,7	QM/8320/25

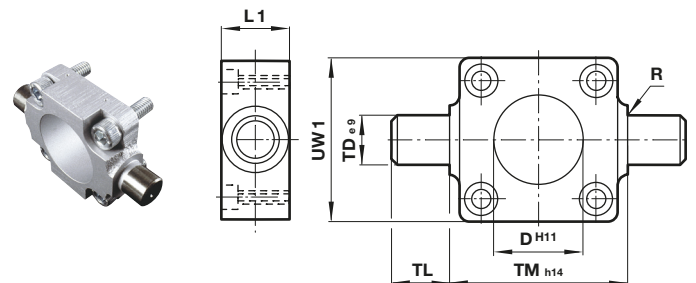
**Front or rear detachable trunnion FH
Conforms to VDMA 24562 part 2, type MT 5/6**

Ø	Ø D h11	L1	R	Ø TD e9	TL	TM h14	UW1	kg	Model (FH)
32	30	16	1	12	12	50	45	0,20	QA/8032/34
40	35	20	1,6	16	16	63	55	0,38	QA/8040/34
50	40	24	1,6	16	16	75	65	0,60	QA/8050/34
63	45	24	1,6	20	20	90	75	1,10	QA/8063/34
80	45	28	1,6	20	20	110	100	1,90	QA/8080/34
100	55	38	2	25	25	132	120	3,50	QA/8100/34
125	60	50	2	25	25	160	145	6,50	QA/8125/34

Centre trunnion – H
Conforms to ISO 15552, type MT4

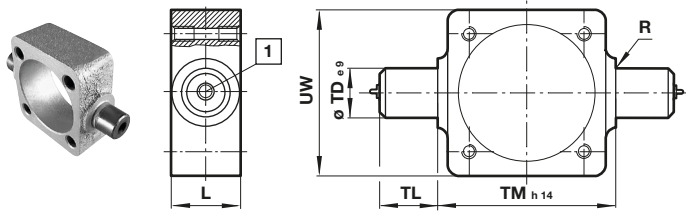

1 Grease nipple up to Ø 125 mm

Adjustable trunnion mounting UH
Conforms to ISO 15552, type MT4

Dimensions in mm
Projection/First angle

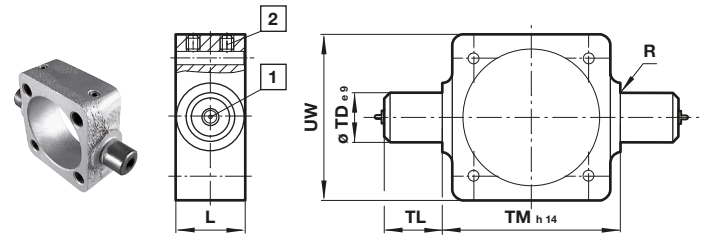

1 Grease nipple up to Ø 125 mm

2 Locking screws

Torque max: Ø 32 & 40 mm = 6 Nm; Ø 50 & 63 mm = 10 Nm;
Ø 80 & 100 mm = 15 Nm; Ø 125 mm = 25 Nm; Ø 160 & 200 mm = 40 Nm

Ø	L	R	Ø TD e9	TL	TM h14	UW	XV min.	XV max.	kg	Model (H)
32	20	1	12	12	50	50	66	80	0,16	QA/8032/28
40	24	1,6	16	16	63	58	76	89	0,35	QA/8040/28
50	28	1,6	16	16	75	70	82	98	0,65	QA/8050/28
63	28	1,6	20	20	90	80	88	107	0,85	QA/8063/28
80	28	1,6	20	20	110	100	97	123	1,2	QA/8080/28
100	38	2	25	25	132	126	107	128	2,3	QA/8100/28
125	50	2	25	25	160	152	136	154	3,3	QM/8125/28
160	50	2,5	32	32	200	192	155	185	5,3	QM/8160/28
200	50	2,5	32	32	250	240	170	200	9,4	QM/8200/28
250	60	3,2	40	40	320	318	193	217	18	QM/8250/28
320	70	3,2	50	50	400	400	215	245	30	QM/8320/28

Ø	L	R	Ø TD e9	TL	TM h14	UW	XV min.	XV max.	kg	Model (UH)
32	20	1	12	12	50	50	66	80	0,16	QA/8032/40
40	24	1,6	16	16	63	58	76	89	0,35	QA/8040/40
50	28	1,6	16	16	75	70	82	98	0,65	QA/8050/40
63	28	1,6	20	20	90	80	88	107	0,85	QA/8063/40
80	28	1,6	20	20	110	100	97	123	1,2	QA/8080/40
100	38	2	25	25	132	126	112	128	2,3	QA/8100/40
125	50	2	25	25	160	152	136	154	3,3	QM/8125/40
160	50	2,5	32	32	200	192	155	185	5,3	QM/8160/40
200	50	2,5	32	32	250	240	170	200	9,4	QM/8200/40

Style 'UH': It is most important that the locking screws which secure the mounting to the tie rod are tightened to the torque figures shown in the table below. For maximum energy input, consult our Technical Service.

Note: Style 'H': These mountings are only supplied assembled complete with the cylinder. Unless otherwise specified, units will be supplied with dimension 'XV' plus half the stroke length. 'XV' = Distance from the piston rod shoulder to the centre of the mounting.

Unless otherwise specified, units will be supplied with dimension 'XV' plus half the stroke length. 'XV' = Distance from the piston rod shoulder to the centre of the mounting.

Rear eye R
Conforms to ISO 15552, type MP4

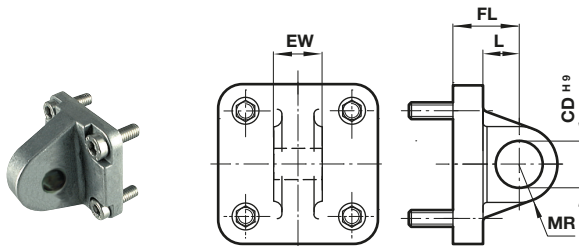

Ø	Ø CD H9	EW	FL	L	MR	kg	Model (R)
32	10	25,8	22	13	9	0,09	QA/8032/27
40	12	27,8	25	16	12	0,11	QA/8040/27
50	12	31,7	27	17	12	0,17	QA/8050/27
63	16	39,7	32	22	15	0,24	QA/8063/27
80	16	49,7	36	22	15	0,37	QA/8080/27
100	20	59,7	41	27	20	0,59	QA/8100/27
125	25	69,7	50	33	25	3,20	QM/8125/27
160	30	89,7	55	35,5	30	6,1	QM/8160/27
200	30	89,7	60	37	30	6,8	QM/8200/27

Trunnion support S
Conforms to ISO 15552, type AT4

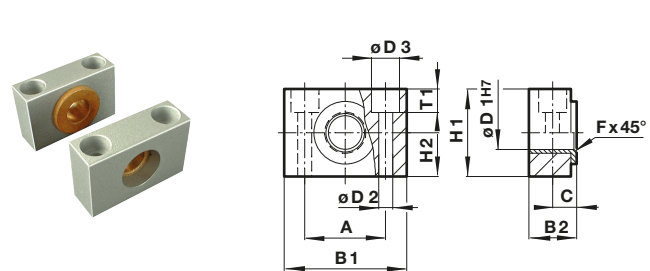

Ø	A	B 1	B 2	C	Ø D1 H7	Ø D2	Ø D3	F x 45°	H 1	H 2	T1	kg	Model (S)
32	32	46	18	10,5	12	6,6	11	1	30	15	6,8	0,10	QA/8032/41
40/50	36	55	21	12	16	9	15	1,6	36	18	9	0,14	QA/8040/41
63/80	42	65	23	13	20	11	18	1,6	40	20	11	0,18	QA/8063/41
100/125	50	75	28,5	16	25	14	20	2	50	25	13	0,34	QA/8100/41
160/200	60	92	39	21,5	32	18	26	2,5	60	25	15,5	1,9	QA/8160/41

**Universal piston rod eye UF
Conforms to DIN ISO 8139**
**Universal rear eye UR
Conforms to ISO 15552, type MP6**

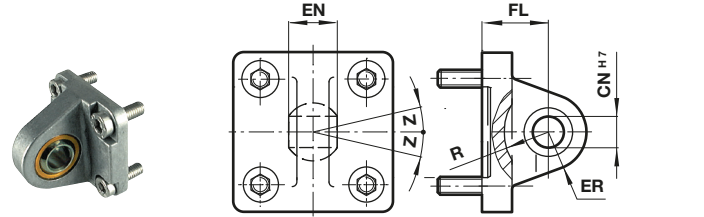
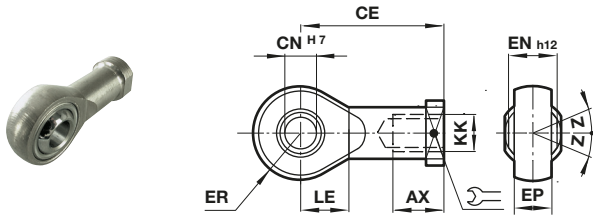
 Dimensions in mm
Projection/First angle

Ø	Thread KK	AX	CE	Ø CN H7	EN -0,1	ER	LE	Z	kg	Model (UF)
32	M10x1,25	20	43	10	14	14	15	13°	0,09	QM/8025/32
40	M12x1,25	22	50	12	16	16	17	13°	0,13	QM/8040/32
50/63	M16x1,5	28	64	16	21	21	22	15°	0,33	QM/8050/32
80/100	M20x1,5	33	77	20	25	25	26	15°	0,67	QM/8080/32
125	M27x2	51	110	30	37	35	36	15°	1,35	QM/8125/32
160/200	M36x2	56	125	35	43	40	41	16°	3	QM/8160/32
250	M42x2	60	142	40	49	45	46	17°	6,4	QM/8250/32
320	M48x2	65	160	50	60	58	59	12°	8,7	QM/8320/32

Ø	Ø CN H7	EN	ER	FL	R	Z	kg	Model (UR)
32	10	14	16	22	14,5	13°	0,15	QA/8032/33
40	12	16	18	25	18	13°	0,25	QA/8040/33
50	16	21	21	27	19	15°	0,40	QA/8050/33
63	16	21	23	32	24	15°	0,55	QA/8063/33
80	20	25	28	36	24	15°	0,90	QA/8080/33
100	20	25	30	41	29	15°	1,50	QA/8100/33
125	30	37	40	50	36	15°	2,70	QM/8125/33
160	35	43	44	55	41	16°	4,6	QM/8160/33
200	35	43	48	60	42	16°	7,3	QM/8200/33
250	40	49	50	70	47	10°	16,5	QM/8250/33
320	50	60	58	80	52	8°	26	QM/8320/33

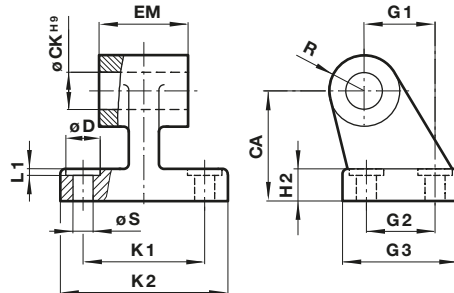
**Wide hinge SW
Conforms to ISO 15552, type AB7**

Ø	CA	Ø CK H9	Ø D	H2	EM	G1	G2	G3	K1	K2	L1	R	Ø S	kg	Model (SW)
32	32	10	11	7	25,5	21	18	31	38	50	1,6	10	6,6	0,05	MP19493
40	36	12	11	9	27,5	24	22	35	41	54	1,6	11	6,6	0,07	MP19494
50	45	12	15	11	31,5	33	30	45	50	65	1,6	13	9	0,14	MP19495
63	50	16	15	12	39,5	37	35	50	52	67	1,6	15	9	0,18	MP19496
80	63	16	18	14	49,5	47	40	60	66	84	2,5	15	11	0,28	MP19497
100	71	20	18	15	59,5	55	50	70	76	94	2,5	19	11	0,42	MP19498
125	90	25	20	20	70,5	70	60	90	94	124	3,2	22	14	2,70	MP19499
160	115	30	20	25	89,5	97	88	126	118	156	4	31	14	6,3	MP19679
200	135	30	26	30	89,5	105	90	130	122	162	4	31	18	8	MP19683
250	165	40*1)	40	35	109,5	128	110	160	150	200	4	39	22	13,4	MP19446
320	200	45*1)	48	40	119,5	150	122	186	170	234	4	44	26	22	MP19447

Narrow hinge SS

Dimensions in mm
Projection/First angle

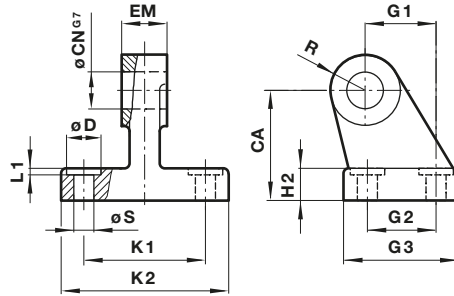

Ø	CA	Ø CN G7	Ø D	H2	EM	G1	G2	G3	K1	K2	L1	R	Ø S	kg	Model (SS)
32	32	10	11	8	10	21	18	31	38	51	1,6	10	6,6	0,15	MP19931
40	36	12	11	10	12	24	22	35	41	54	1,6	11	6,6	0,20	MP19932
50	45	16	15	12	16	33	30	45	50	65	1,6	13	9	0,48	MP19933
63	50	16	15	12	16	37	35	50	52	67	1,6	15	9	0,50	MP19934
80	63	20	18	14	20	47	40	60	66	86	2,5	15	11	0,75	MP19935
100	71	20	18	15	20	55	50	70	76	96	2,5	19	11	1,20	MP19936
125	90	25	20	20	30	70	60	90	94	124	3,2	22	14	2,50	MP19937
160	115	35	20	25	35	97	88	126	118	156	4	31	14	6,00	MP19938
200	135	35	26	30	35	105	90	130	122	162	4	31	18	7,60	MP19939

Swivel hinge US

Conforms to VDMA 24562 part 2

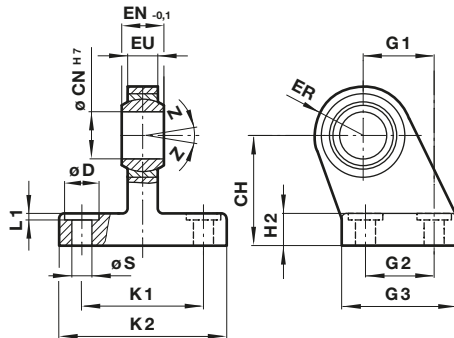

Ø	CH	Ø CN H7	Ø D	EN -0,1	ER	EU	G1	G2	G3	H2	K1	K2	L1	Ø S	Z	kg	Model (US)
32	32	10	11	14	16	10,5	21	18	31	10	38	51	1,6	6,6	13°	0,19	MP40310
40	36	12	11	16	18	12	24	22	35	10	41	54	1,6	6,6	13°	0,24	MP40311
50	45	16	15	21	21	15	33	30	45	12	50	65	1,6	9	13°	0,46	MP40312
63	50	16	15	21	23	15	37	35	50	12	52	67	1,6	9	15°	0,59	MP40313
80	63	20	18	25	28	18	47	40	60	14	66	86	2,5	11	15°	1,03	MP40314
100	71	20	18	25	30	18	55	50	70	15	76	96	2,5	11	15°	1,40	MP40315
125	90	30	20	37	40	25	70	60	90	20	94	124	3,2	14	15°	3,10	MP71355
160	115	35	20	43	44	28	97	88	126	25	118	156	4	14	15°	6,40	MP71356
200	135	35	26	43	47	28	105	90	130	30	122	162	4	18	15°	9,10	MP71357

QA/8000/51 – Guide blocks (plain bearings)

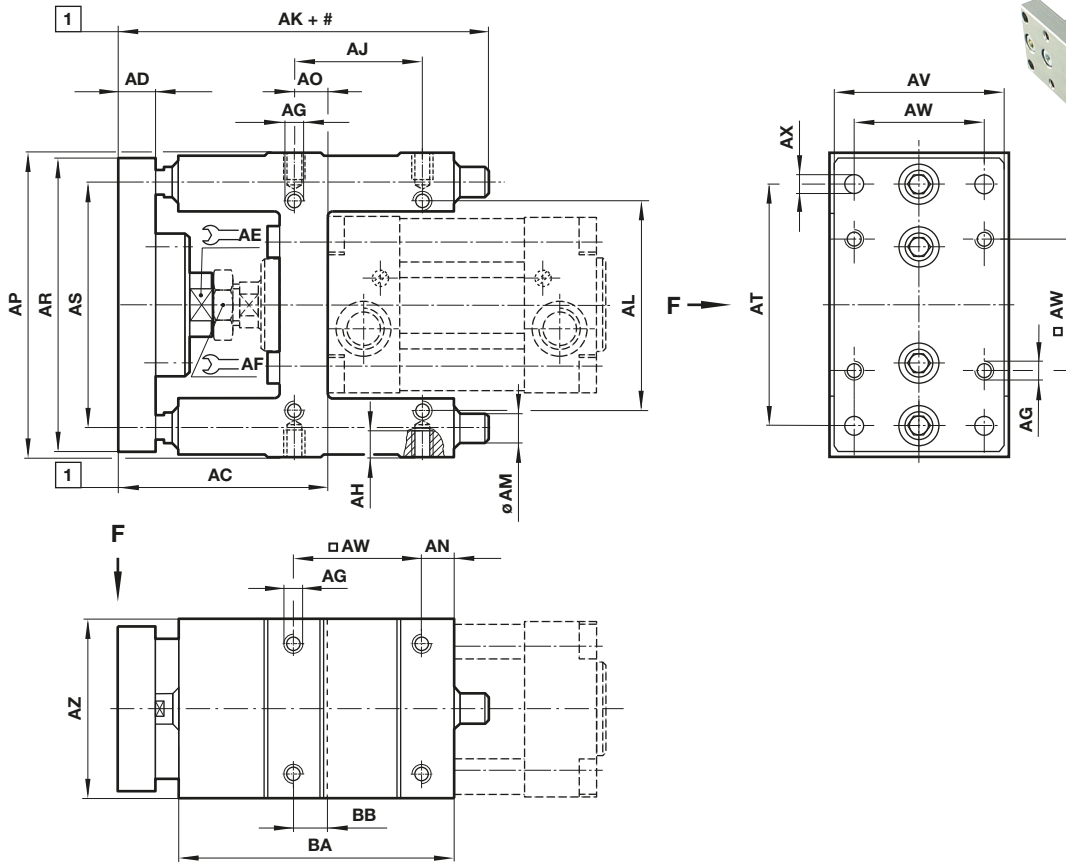
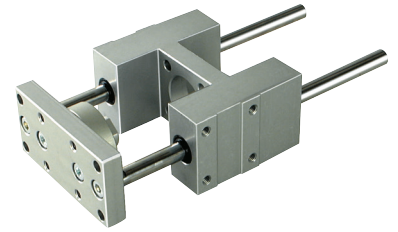

Dimensions in mm
Projection/First angle

- # Stroke
- 1 Adjustment range
- Ø 32 & 40 = +2
- Ø 50 & 63 = +4
- Ø 80 & 100 = +6

Ø	AC	AD	AE	AF	AG	AH	AJ	AK	AL	Ø AM	AN	AO	AP
32	69	12	15	17	M 6	10	32,5	110	58	10	6	9	100
40	74	12	15	19	M 6	10	38	122	64	12	6	11	106
50	91,5	15	22	24	M 8	12	46,5	135	80	12	6	19	125
63	92	15	22	24	M 8	12	56,5	153	95	12	7	15	132
80	106	15	27	30	M 10	15	50	180	130	16	9	14	165
100	111	15	27	30	M 10	17	70	199	150	16	9	19	185
Ø	AR	AS	AT	AV	AW	Ø AX	AZ	BA	BB	kg at 0 mm	kg per 100 mm	Model	
32	90	74	78	45	32,5	6,6	48	76	9	1,0	0,06	QA/8032/51/*	
40	100	80	84	50	38	6,6	56	85	11	1,2	0,09	QA/8040/51/*	
50	120	96	100	60	46,5	9	66	99	19	1,8	0,09	QA/8050/51/*	
63	125	104	105	70	56,5	9	76	114	15	2,2	0,09	QA/8063/51/*	
80	155	130	130	90	72	11	98	134,5	25	4,1	0,16	QA/8080/51/*	
100	175	150	150	110	89	11	118	153,5	28,5	5,8	0,16	QA/8100/51/*	

* Insert standard stroke length: 50, 100, 160, 200, 250, 320, 400 and 500 mm, use nearest standard stroke.
Note: Supplied complete with mounting screws for cylinders

Maximum load

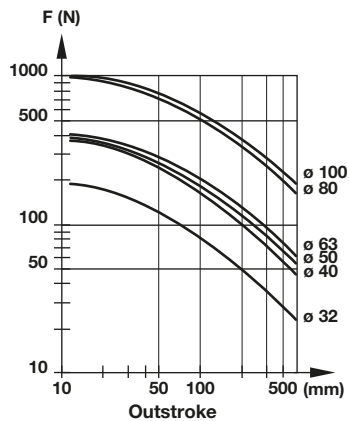

QA/8000/61 – Guide blocks (roller bearings)

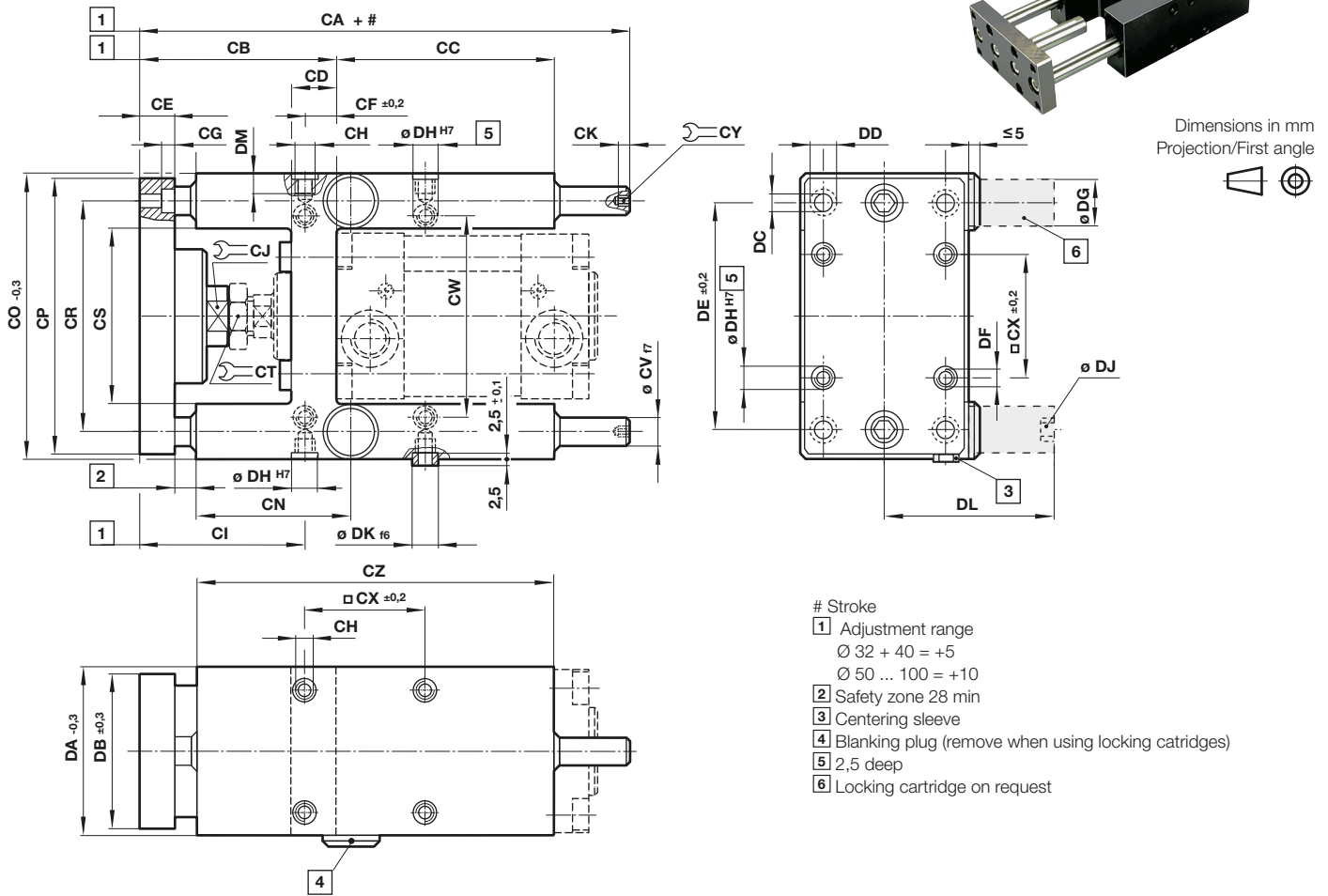

Ø	CA	CB	CC	CD	CE	CF ±0,2	CG	CH	CI	CJ	CK	CN	CO -0,3
32	177	100	65	28	12	15,3	6,5	M 6	84,5	13	5	61	97
40	192	111	69	33	12	23	6,5	M 6	88	15	6	67	115
50	237	128	65	40	15	33,8	9	M 8	94	22	6	75,5	137
63	237	128	97	40	15	29,3	9	M 8	98,5	22	6	80	152
80	280	151	112	50	20	37	11	M 10	114	27	7	92	189
100	280	156	112	55	20	40,5	11	M 10	115,5	27	7	93	213
Ø	CP	CR	CS	CT	ØCV F7	CW	CX ±0,2	CY	CZ	DA -0,3	DB ±0,3	DC	Ø DD
32	90	74	50,5	17	12	61	32,5	5	125	50	45	6,6	11
40	110	87	58,5	19	16	69	38	6	140	58	54	6,6	11
50	130	104	70,5	24	20	85	46,5	6	150	70	63	9	15
63	145	119	85,5	24	20	100	56,5	6	182	85	80	9	15
80	180	148	105,5	30	25	130	72	8	215	105	100	11	18
100	200	172	130,5	30	25	150	89	8	220	130	120	11	18
Ø	DE ±0,2	DF	Ø DG	Ø DH H7	DJ	Ø DK f6	DL	DM	kg at 0 mm	kg per 100 mm	Locking force (N)	Cartridge *1)	Model
32	78	M 6	20	9	M 5	9	45	14	1,2	0,18	600	QA/8032/63	QA/8032/61/*
40	84	M 6	24	9	G 1/8	9	61,5	14	2,2	0,32	1000	QA/8040/63	QA/8040/61/*
50	100	M 8	30	11	G 1/8	11	76,5	16	3,6	0,49	1500	QA/8050/63	QA/8050/61/*
63	105	M 8	30	11	G 1/8	11	76,5	16	4,6	0,49	1500	QA/8050/63	QA/8063/61/*
80	130	M 10	48	13	G 1/8	13	119	20	8,7	0,77	3000	QA/8080/63	QA/8080/61/*
100	150	M 10	48	13	G 1/8	13	119	20	11	0,77	3000	QA/8080/63	QA/8100/61/*

* Insert standard stroke length: 50, 100, 160, 200, 250, 320, 400 and 500 mm, use nearest standard stroke.

Note: Supplied complete with mounting screws for cylinders

*1) Locking cartridges should be ordered separately. Passive - pressure to unlock. Two required per guide block.

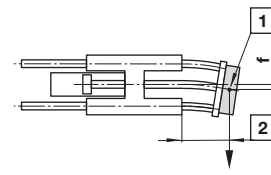
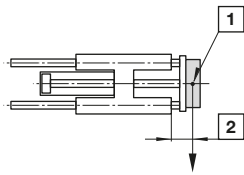
Maximum load for QA/8000/61

 Dimensions in mm
Projection/First angle

- 1** Centre of gravity load capacity
- 2** Outstroke

Maximum load capacity is dependent on the outstroke of a horizontally installed guide unit. In the case of short stroke operation, the load capacity figures taken from the diagram must be multiplied by the correction factor (diagram 2). In the curves of load capacity (diagram 1), the short stroke corrections have already been taken into account for an outstroke > 60 mm.

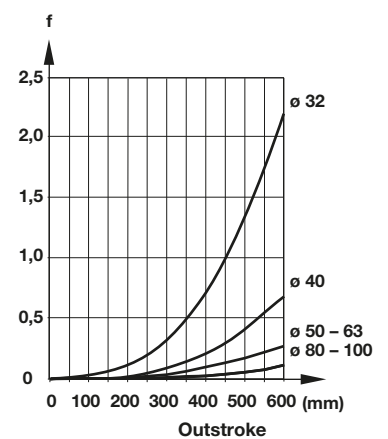
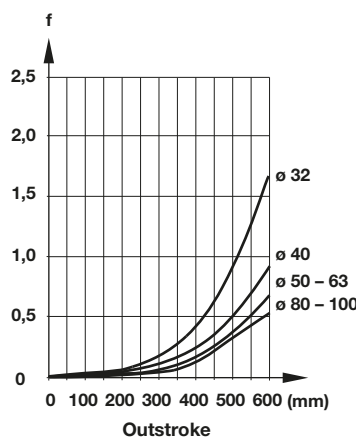
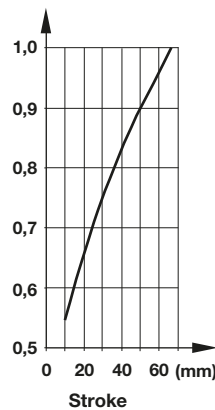
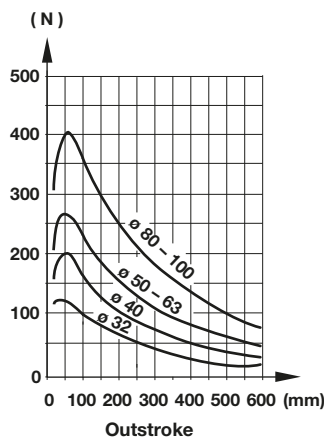
The total deflection of guide rods will be determined by the addition of that due to own weight (diagram 3) and that due to load capacity (diagram 4).

Maximum load capacity depending on outstroke (diagram 1)
Correction factor (diagram 2)
Deflection caused by own weight (diagram 3)
Deflection caused by a load of 10 N (diagram 4)
Load capacity
Correction factor
Deflection (mm)
Deflection (mm)

In the case of shock load applications, the figures given in the diagrams above must be reduced by a factor of 2

QA/8000/81 – Guide blocks (long coupling)
QA/8000/85 – Guide blocks (short coupling)

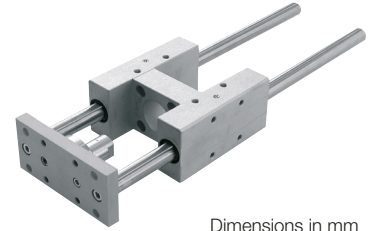
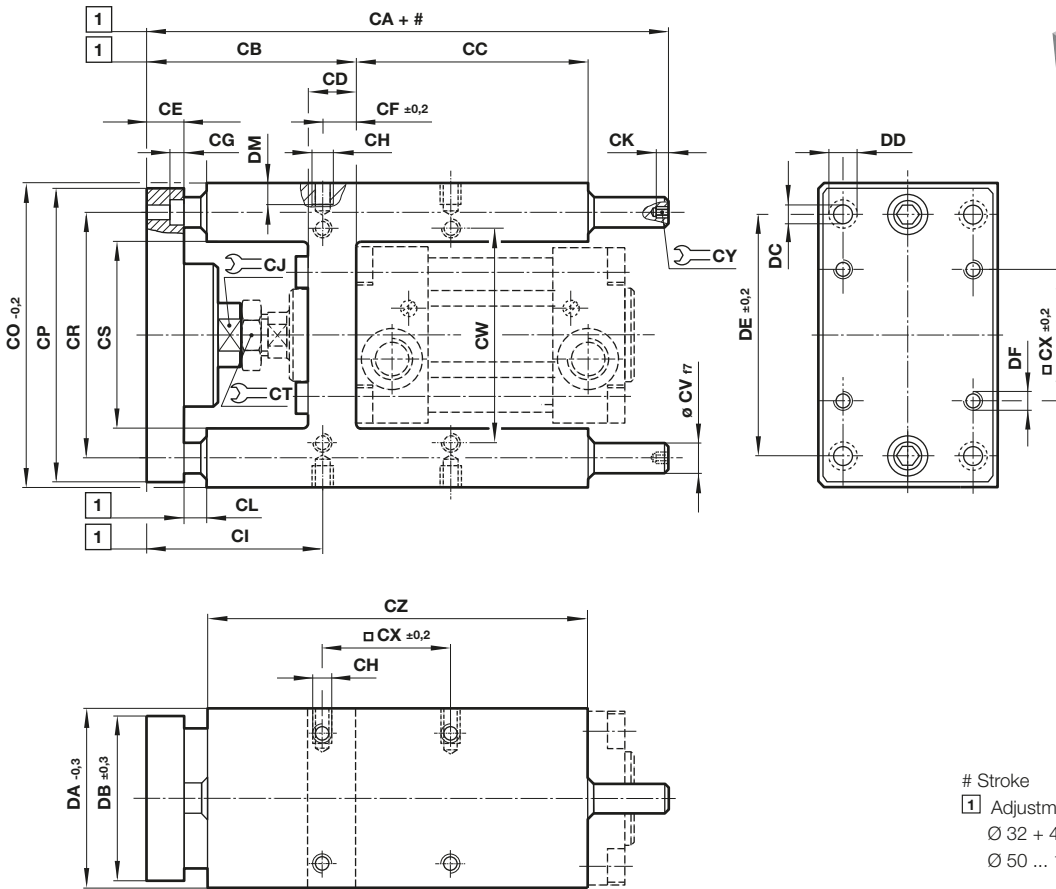

Dimensions in mm
Projection/First angle



Stroke
 1 Adjustment range
 Ø 32 + 40 = +5
 Ø 50 ... 100 = +10

Ø	CA /81	CA /85	CB + /81	CB + /85	CC	CD	CE	CF ±0,2	CG	CH	CI /81	CI /85	CJ
32	174	149	89	64	75	24	12	4,3	6,5	M 6	84,7	59,7	15
40	189	164	99	74	80	28	12	11	6,5	M 6	88	63	15
50	210	181	113	88	78	34	15	18,8	8,5	M 8	94,2	69,2	20
63	235	210	114	89	106	34	15	15,3	9	M 8	98,7	73,7	20
80	265	240	139	114	111	50	20	25	11	M 10	114	89	26
100	288	265	145	120	128	55	20	30	11	M 10	115	90	26
Ø	CK	CL /81	CL /85	CO ±0,2	CP	CR	CS	CT	ØCV r8	CW	CX ±0,2	CY	CZ
32	5	27	2	97	93	74	51	17	12	61	32,5	5	125
40	6	27	2	115	112	87	58,2	19	16	69	38	6	140
50	6	28	3	137	134	104	70,2	24	20	85	46,5	6	148
63	6	27	2	152	147	119	85,2	24	20	100	56,5	6	178
80	7	35	10	189	180	148	105,5	30	25	130	72	8	195
100	7	35	10	213	206	173	130,5	30	25	150	89	8	218
Ø	DA ±0,2	DB ±0,3	Ø DC	Ø DD	DE ±0,2	DF	DM	kg /81 at 0 mm	kg /85 at 0 mm	kg /81; /85 per 100 mm	Model /81	Model /85	
32	49	45	6,6	11	78	M 6	12	1,2	1,15	0,18	QA/8032/81	QA/8032/85	
40	58	55	6,6	11	84	M 6	12	2,2	2,15	0,32	QA/8040/81	QA/8040/85	
50	70	65	9	15	100	M 8	16	3,6	3,55	0,49	QA/8050/81	QA/8050/85	
63	85	80	9	15	105	M 8	16	4,6	4,55	0,49	QA/8063/81	QA/8063/85	
80	105	100	11	18	130	M 10	20	8,7	8,65	0,77	QA/8080/81	QA/8080/85	
100	130	120	11	18	150	M 10	20	11	10,95	0,77	QA/8100/81	QA/8100/85	

* Insert standard stroke length: 50, 100, 160, 200, 250, 320, 400 and 500 mm, use nearest standard stroke.
 Note: Supplied complete with mounting screws for cylinders

Maximum load for QA/8000/81 and /85

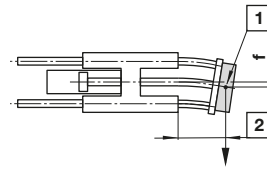
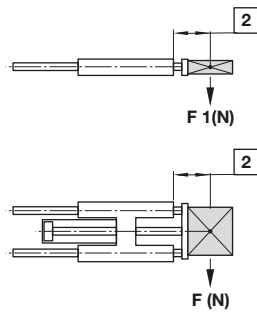
 Dimensions in mm
Projection/First angle

- 1 Centre of gravity load capacity
- 2 Outstroke

$F1 = F \times 0,9$
Static force: $F2 = F \times 2$

Max. load capacity (diagram 1) is dependent on the outstroke of a horizontally installed guide unit.

The total deflection of guide rods will be determined by the addition of the amount of deflection caused by own weight (according to diagram 2) plus the amount of deflection due to load capacity (according to diagram 3).

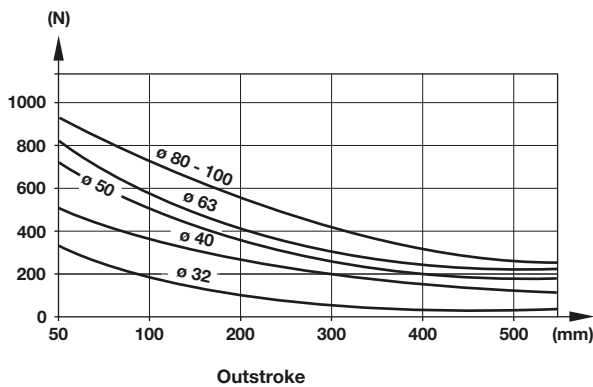
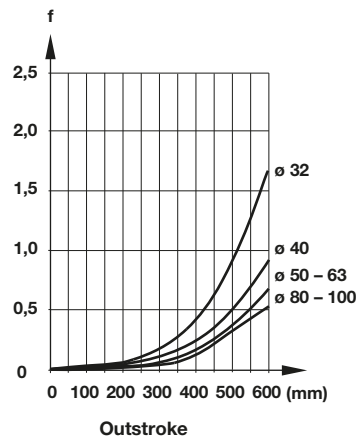
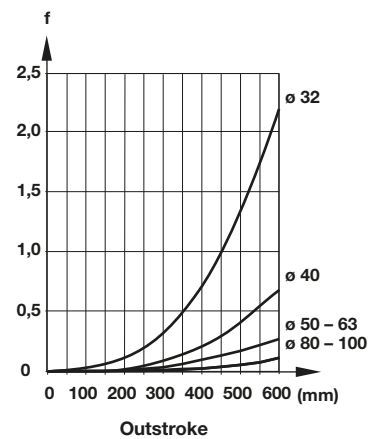
**Maximum load capacity depending on outroke
Deflection caused by a load of 10 N
(diagram 1)
Load capacity**

**Deflection caused by own weight
(diagram 2)
Deflection (mm)**

**Deflection caused by a load of 10 N
(diagram 3)
Deflection (mm)**

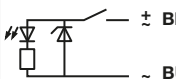
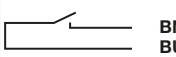
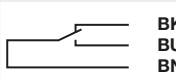
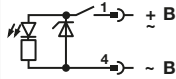
In the case of shock load applications, the figures given in the diagrams above must be reduced by a factor of 2

Technical data - Reed switches - additional informations see data sheet N/en 4.3.005

Symbol	Voltage		Current maximum (mA)	Function	Operating temperature (°C)	LED	Protection class	Plug	Cable length (m)	Cable type	Weight (g)	Model
	(V a.c.)	(V d.c.)										
	10 ... 240	10 ... 170	180	Closer	-25 ... +80	•	IP66	—	2, 5 or 10	PVC 2 x 0,25	37	M/50/LSU/*V
	10 ... 240	10 ... 170	180	Closer	-25 ... +80	•	IP66	—	5	PUR 2 x 0,25	37	M/50/LSU/5U
	10 ... 240	10 ... 170	180	Closer	-25 ... +150	—	IP66	—	2	Silicon 2 x 0,25	37	TM/50/RAU/2S
	10 ... 240	10 ... 170	180	Changeover	-25 ... +80	—	IP66	—	5	PVC 3 x 0,25	37	M/50/RAC/5V
	10 ... 60	10 ... 60	180	Closer	-25 ... +80	•	IP66	M8 x 1	0,3	PVC 3 x 0,25	16	M/50/LSU/CP *1)

* Insert cable length; *1) Plug-in connector see page 11; Color code: BK = black, BN = brown, BU = blue

Drawings

M/50/LSU/*V, M/50/LSU/5U,
TM/50/RAU/2S
Cable length L = 2, 5 or 10 m

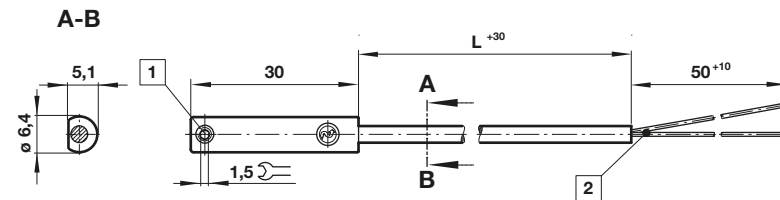

Dimensions in mm
Projection/First angle



M/50/RAC/5V
Cable length L = 5 m

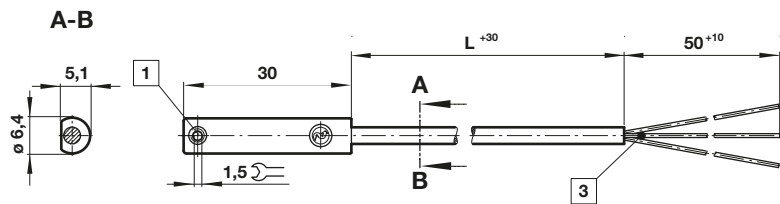

M/50/LSU/CP

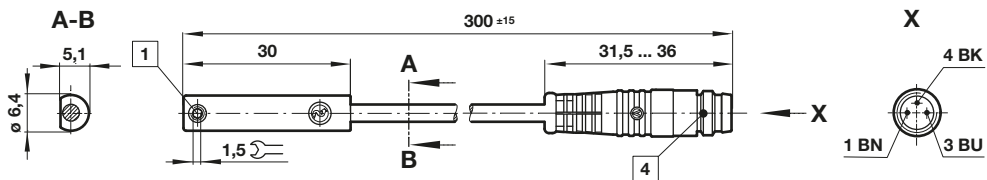

- 1 Fixing screw
- 2 + BN = brown; - BU = blue (output)
- 3 - BK = black; + BN = brown; - BU = blue
- 4 Plug M8 x 1, color code: BK = black; BN = brown; BU = blue

Accessories

Plug-in connector cable with nut



Outer cover	Cable length (m)	Weight (kg)	Connector	Connector
PVC 3 x 0,25	5 m	0,18	M8 x 1	M/P73001/5
PUR 3 x 0,25	5 m	0,18	M8 x 1	M/P73002/5
PUR 3 x 0,34	5 m	0,21	M12 x 1	M/P34594/5

Technical data - Solid state - additional informations see data sheet N/en 4.3.007

Symbol	Voltage (V d.c.)	Current maximum (mA)	Function	Operating temperature (°C)	LED	Protection class	Plug	Cable length (m)	Cable type	Weight (g)	Model
	10 ... 30	150	PNP	-40 ... +80	•	IP67	—	2, 5 or 10	PVC 3 x 0,12	37	M/50/EAP/*V
	10 ... 30	150	PNP	-40 ... +80	•	IP68	—	5	PUR 3 x 0,14	37	M/50/EAP/5U
	10 ... 30	150	PNP	-40 ... +80	•	IP67	M8 x 1	0,3	PVC 3 x 0,14	16	M/50/EAP/CP *1)
	10 ... 30	150	PNP	-40 ... +80	•	IP67	M12 x 1	0,3	PVC 3 x 0,14	16	M/50/EAP/CC *1)
	10 ... 30	150	NPN	-40 ... +80	•	IP67	—	2, 5 or 10	PVC 3 x 0,12	37	M/50/EAN/*V
	10 ... 30	150	Closer	-40 ... +80	•	IP67	M8 x 1	0,3	PVC 3 x 0,14	16	M/50/EAN/CP *1)

* Insert cable length; *1) Plug-in connector below; Color code: BK = black, BN = brown, BU = blue

Drawings

M/50/EAP/*V,
M/50/EAN/*V
Cable length L = 2, 5 or 10 m

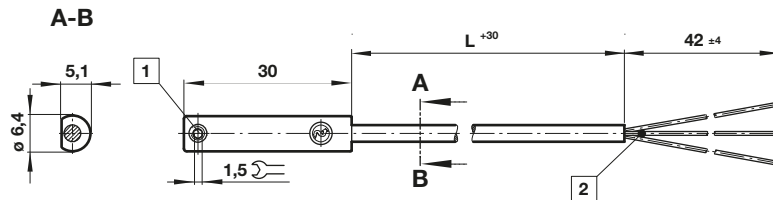

Dimensions in mm
Projection/First angle



M/50/EAP/CP,
M/50/EAN/CP

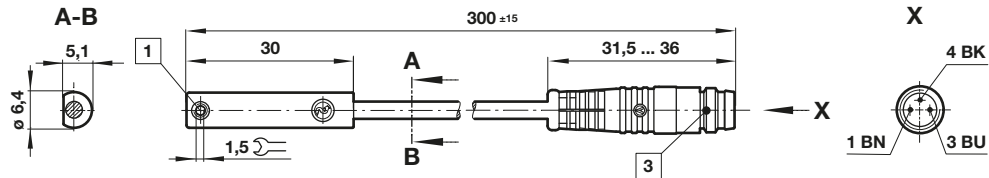

M/50/EAP/CC

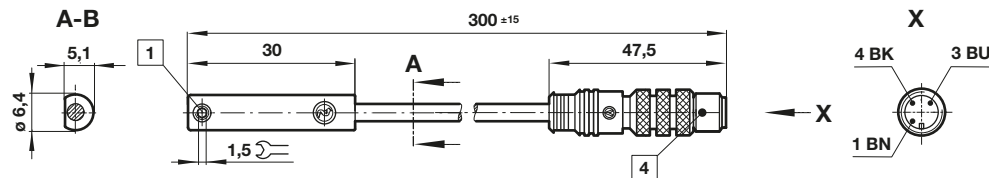

- 1 Fixing screw
- 2 Color code: BK = black; BN = brown; BU = blue
- 3 Plug M8 x 1
- 4 Plug M12 x 1

QM/27/2/1 – Switch mounting brackets

Switch: M/50

Cyl. Ø	A	B	Weight (kg)	Model
32	9	7	0,010	QM/27/2/1
40	8	8	0,010	QM/27/2/1
50	7	5	0,010	QM/27/2/1
63	7	7	0,010	QM/27/2/1
80	7	4	0,010	QM/27/2/1
100	2	2	0,010	QM/27/2/1
125	-4	-3	0,010	QM/27/2/1
160	-10	-9	0,010	QM/27/2/1
200	-17	-14	0,010	QM/27/2/1

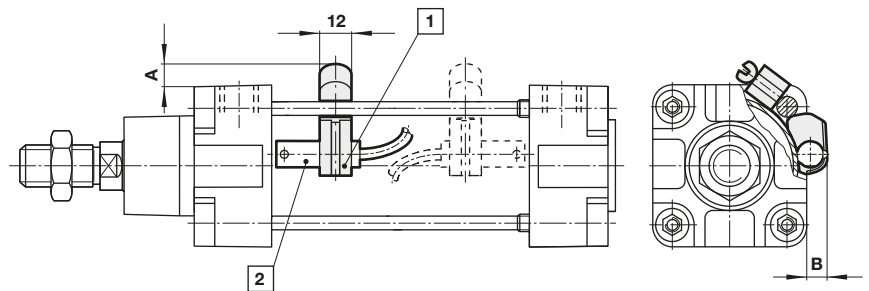

- 1 Switch mounting bracket
- 2 Switch

Technical data - Reed switches - additional informations see data sheet N/en 4.3.021

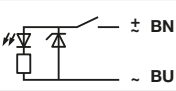
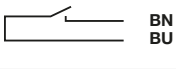
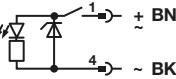
Symbol	Voltage (V a.c./V d.c.)	Current maximum (A)	Function	Temperature (°C)	LED	Protection class	Features	Cable length (m)	Cable type	Weight (g)	Model
	10 ... 240	1	Closer	-20 ... +80	•	IP66	—	2, 5 or 10	PVC 2 x 0,75	108 (2 m)	QM/32/*
	10 ... 240	1	Closer	-20 ... +80	•	IP66	—	2	PUR 2 x 0,75	108	QM/32/2/PU
	10 ... 240	2	Closer	-20 ... +150	—	IP66	High temperature	2, 5 or 10	Silicon 2 x 0,75	102 (2 m)	TQM/31/*
	10 ... 240	1	Closer	-20 ... +80	•	IP66	Plug M12 x 1	—	—	15	QM/32/P *1)

Technical data - Solid state - additional informations see data sheet N/en 4.3.025

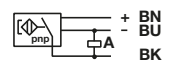
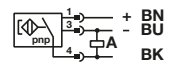
Symbol	Voltage (V d.c.)	Current maximum (mA)	Function	Temperature (°C)	LED	Protection class	Features	Cable length (m)	Cable type	Weight (g)	Model
	10 ... 30	200	PNP	-20 ... +80	•	IP66	—	2, 5 or 10	PVC 3 x 0,5	102 (2 m)	QM/132/*
	10 ... 30	200	PNP	-20 ... +80	•	IP66	—	5	PUR 3 x 0,34		QM/132/5/PU
	10 ... 30	200	PNP	-20 ... +80	•	IP66	Plug M12 x 1	—	—	15	QM/132/P *1)

* Insert cable length

*1) Plug-in connector see page below; Color code: BK = black, BN = brown, BU = blue

Drawings

TQM/31, QM/32, QM/132

QM/32/P, QM/132/P

Dimensions in mm
Projection/First angle

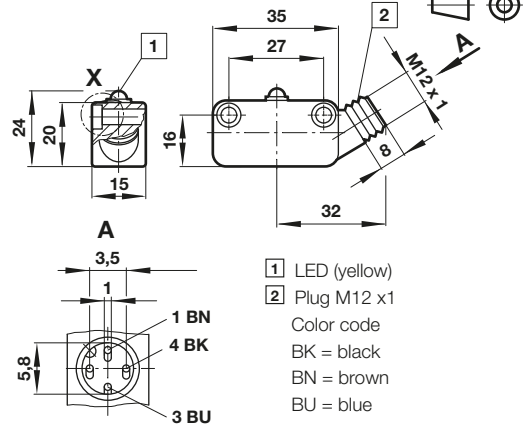
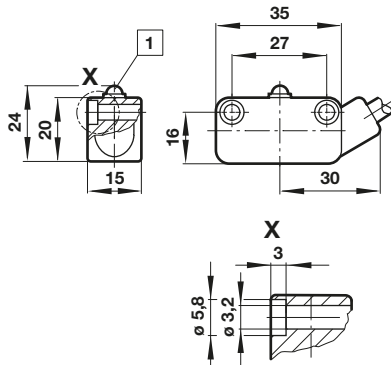

Accessories

Plug-in connector cable with nut



Outer cover	Cable length (m)	Weight (kg)	Connector	Connector
PVC 3 x 0,34	5 m	0,21	M12 x 1	M/P34692/5
PUR 3 x 0,34	5 m	0,21	M12 x 1	M/P34594/5

QM/31/000/22 – Switch mounting brackets
Switches: TQM/31, QM/32, QM/132

 Dimensions in mm
Projection/First angle

Cyl. Ø	A	B	Weight (kg)	Model
32	4,5	38	0,026	QM/31/032/22
40	5,5	43	0,026	QM/31/032/22
50	4,5	48	0,026	QM/31/032/22
63	4,5	53	0,026	QM/31/032/22
80	1,5	61	0,028	QM/31/080/22
100	0,5	68	0,028	QM/31/080/22
125	-1	79	0,028	QM/31/080/22
160	0	91,5	0,023	QM/31/160/22
200	-4	106	0,023	QM/31/160/22
250	-3	138	0,041	QM/31/250/22
320	-21	154	0,080	QM/31/320/22

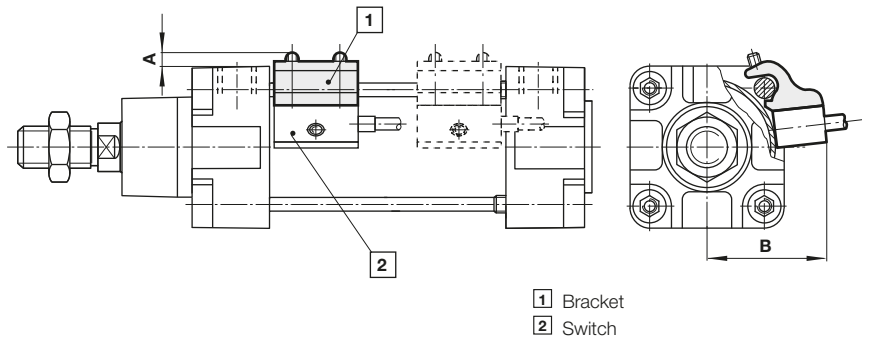
Pneumatic proximity sensor - additional informations see data sheet N/en 4.3.061

Symbol	Operating pressure	Flow rate	Orifice size	Temperature	Optical indicator	Connections	Model
	2 ... 6 bar	40 l/min	2 mm	-15 ... +60°C	•	Pipes for 3 mm I/D tubing	QM/140

QM/140/010/22 – Bracket with holding strap
Pneumatic switch: QM/140

Cyl. Ø	A	B	Weight (kg)
32	31,5	18,5	0,020
40	30,5	18,5	0,020
50	31,5	18,5	0,020
63	29,5	18,5	0,020
80	30,5	18,5	0,020
100	30	18,5	0,020

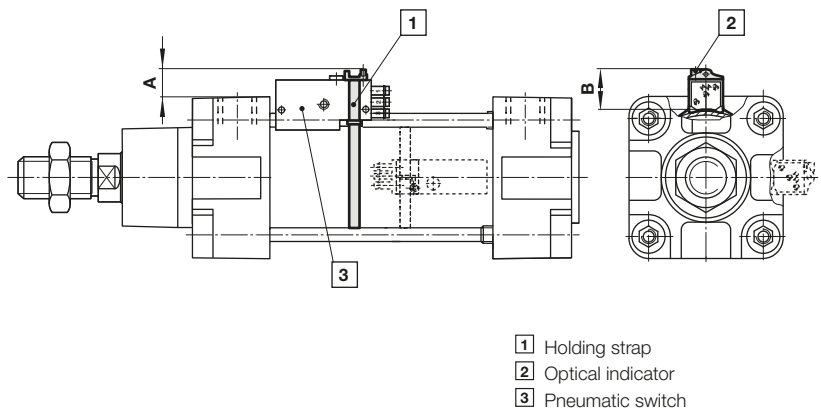
Warning

These products are intended for use in industrial compressed air systems only. Do not use these products where pressures and temperatures can exceed those listed under

»Technical features/data«.

Before using these products with fluids other than those specified, for non-industrial applications, life-support systems or other applications not within published specifications, consult IMI Precision Engineering, Norgren GmbH.

Through misuse, age, or malfunction, components used in fluid power systems can fail in various modes.

The system designer is warned to consider the failure modes of all component parts used in fluid power systems and to provide adequate safeguards to prevent personal injury or damage to equipment in the event of such failure.

System designers must provide a warning to end users in the system instructional manual if protection against a failure mode cannot be adequately provided.

System designers and end users are cautioned to review specific warnings found in instruction sheets packed and shipped with these products.