

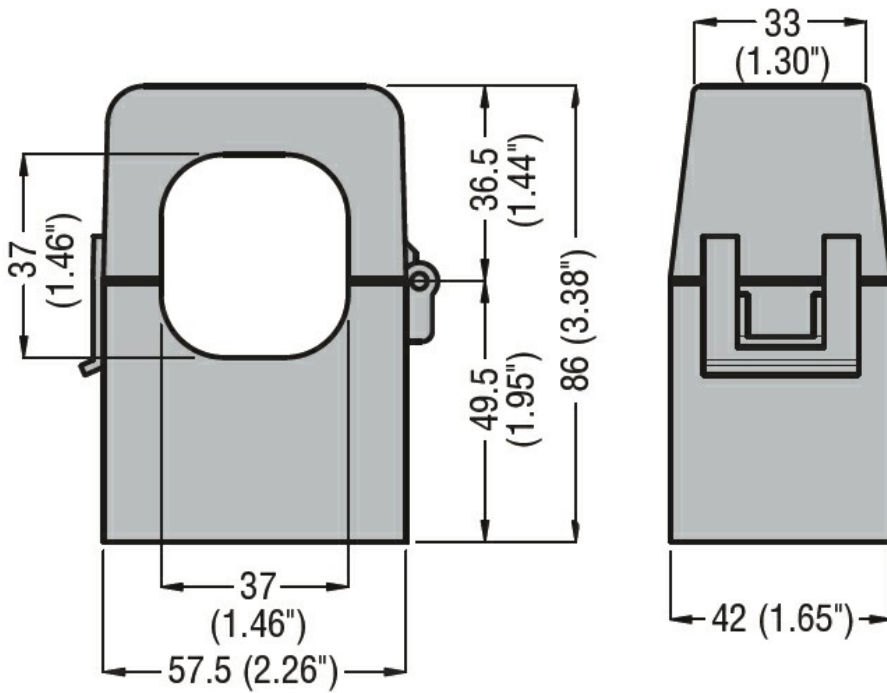

Current inputs			
Primary current I _{pn} (/5)		A	400
Operational frequency	min	Hz	50
	max	Hz	60
Secondary output current		A	5
Overload withstand I _{pn}		%	120
Burden	cl. 0.5	VA	0.5
	cl. 1	VA	1.5
Insulations			
Rated insulation voltage U _i IEC/EN		V	720
IEC rated short-time thermal current I _{th}		I _{th} for s	40...60
IEC rated dynamic current I _{dyn}		I _{th} for s	2.5
Insulation dry type			Class E
Mechanical features			
Terminals type			2m pre-wired
Weight		g	380
Ambient conditions			
Temperature	Operating temperature	min	°C -25
		max	°C +50
Storage temperature		min	°C -40
		max	°C +80
Relative humidity		%	90
Dimensions			



Certifications and compliance

Certifications

IEC/EN/BS 61869-1

IEC/EN/BS 61869-2

Compliance

EAC

ETIM classification

EC000066 - Power contactor, AC switching