

NV-175

AC/DC Power Supply Series

APPLICATION NOTE

1. INPUT	3
AC INPUT LINE REQUIREMENTS	3
2. DC OUTPUT	3
OUTPUT VOLTAGES	3
REMOTE SENSE	3
EFFICIENCY	4
NO LOAD OPERATION	4
SERIES/PARALLEL CONNECTION	4
OUTPUT CHARACTERISTICS	5
Ripple/Noise	5
+5/+3.3V POWER SEQUENCING FOR NV-175	6
POWER SUPPLY TIMING	6
POWER SUPPLY TIMING (-N3 & -N4 Versions)	7
SIGNALS	8
Important note: The pin numbers referenced in this section relate to the standard output connector version. For pin numbering of the right angled output connector variant, please see the “Pin Definition” section.....	8
STANDBY SUPPLY (+ Output) (J1-12)	8
POWER GOOD SIGNAL (J1-11) (available on ‘-N’, ‘-N1’ or ‘-N2’ versions only.)	8
ATX POWER GOOD SIGNAL (J1-11) (available on ‘-N3’ and ‘-N4’ versions only.)	8
REMOTE ON/OFF – GLOBAL ON/OFF (J1-23) (available on ‘-N’, ‘-N1’ and ‘-N2’ versions only.)	9
ATX REMOTE ON/OFF – GLOBAL ON/OFF (J1-23) (available on ‘-N3’ and ‘-N4’ versions only.)	10
OVERSHOOT AT TURN ON/OFF	10
OUTPUT PROTECTION	10
COOLING REQUIREMENTS	11
TEMPERATURE DERATING	12
ELECTROMAGNETIC COMPATIBILITY	12
Installation for optimum EMC performance	13
RELIABILITY	14
CONNECTION	15
Input	15
Output	15
Pin Definition (standard [vertical] output connector)	15
Pin Definition (variants fitted with right angled output connector)	16
MOUNTING	16
WEIGHTS	17
TEST RESULTS	17

1. INPUT

AC INPUT LINE REQUIREMENTS

See datasheet for specification of input line requirements (including Input voltage range, Input frequency, Input harmonics, Input current and leakage current)

The power supply will automatically recover from AC power loss and shall be capable of start-up under peak loading at 90VAC.

Repetitive ON/OFF cycling of the AC input voltage shall not damage the power supply or cause the input fuse to blow.

- Input Fuse
Not user serviceable. 3.15A, time lag, high breaking capacity, ceramic fuse.
- Input Undervoltage
The power supply is protected against the application of an input voltage below the minimum specified so that it shall not cause damage to the power supply.

2. DC OUTPUT

OUTPUT VOLTAGES

Output channels 1-4 all have a common 0V. Outputs 1-3 are all positive and output 4 is negative. See the datasheet for full specifications of the output, including adjustment range, output current, remote-sensing capability, regulation, ripple & noise and setting accuracy.

All Auxiliary supplies are present whilst the ac input is present, irrespective of the state of the other channels (or remote on/off).

On the '-N' and '-N2' versions, the auxiliary supply is an independent, 5V/2A (-N) or 13.5V/1A (-N2), floating, isolated output. The 5V/2A auxiliary supply on '-N3' versions shares a common 0V with all other outputs.

REMOTE SENSE

Remote sensing is provided to compensate for voltage drops in the power connections to the load. Remote sense is available for Output 1 and Output 2. Up to 0.5V total line drop can be compensated. The remote sense lines may be connected as follows: -

- If remote sense is not required, simply do not connect either '+sense' or '-sense'
- If remote sense is required, connect '-sense' and '+sense' to the corresponding point at the load (see Figure 1 for details)
- Note – do not connect remote sense across an output fuse.

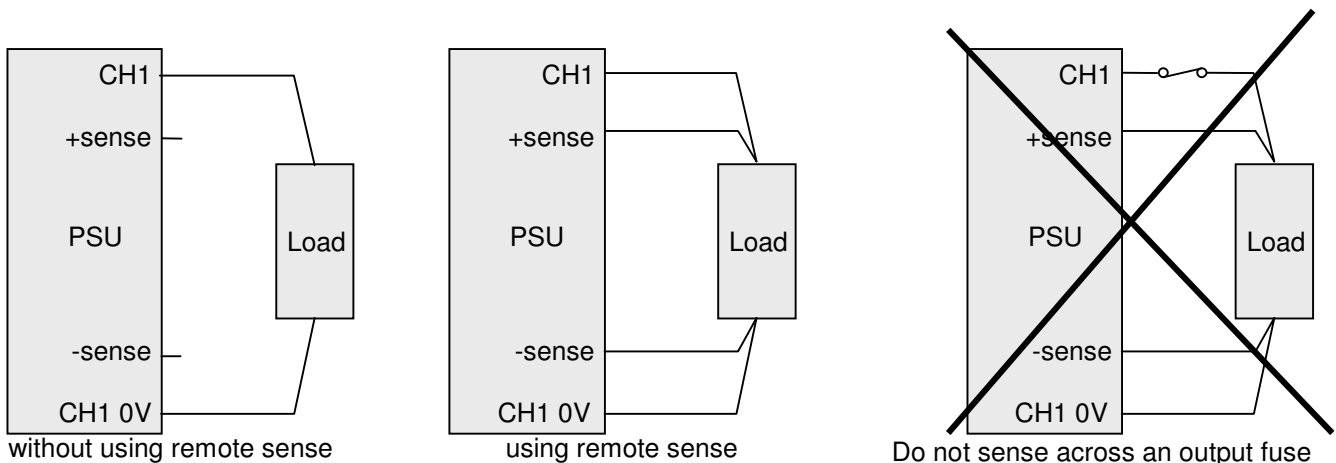
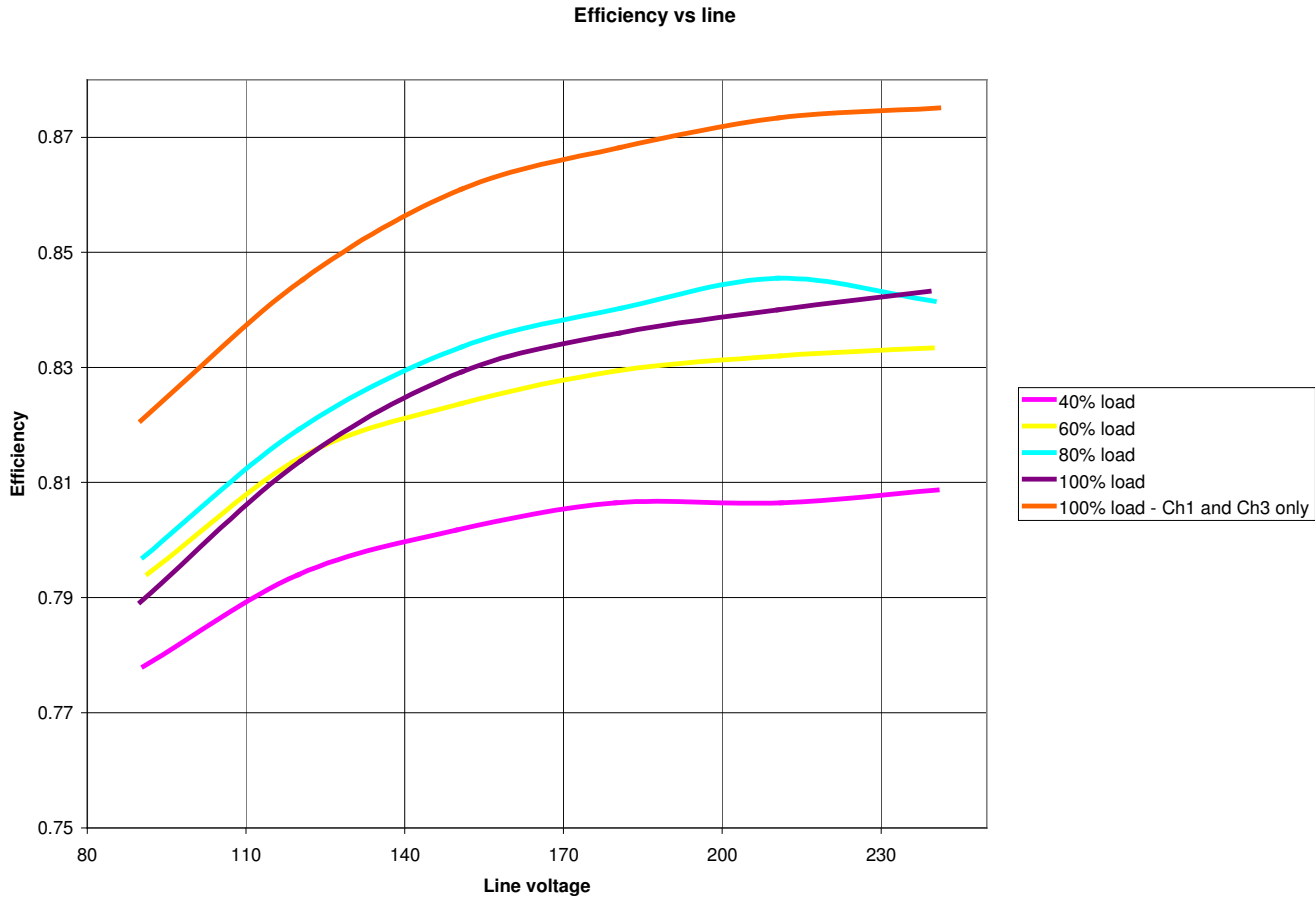

Figure 1: How to connect power supply to load

EFFICIENCY

Note that the following charts show the efficiencies when the power supply is loaded with typical customer loads (multi output). Even better efficiencies are possible if the unit is used as a single output power supply.



NO LOAD OPERATION

No minimum load is required for the power supply to operate within specification.

Figure 2. NV-175 Efficiency Chart

SERIES/PARALLEL CONNECTION

It is possible to connect multiple NV-175 in series. Do not exceed 160V for the total voltage of outputs connected in series.

The outputs connected in series are non-SELV (Safety Extra Low Voltage) if the total output voltage + 30% of the highest maximum rated output voltage exceeds 60V (the 30% addition allows for a single fault in any one individual channel).

Outputs must not be connected in parallel.

OUTPUT CHARACTERISTICS

Ripple/Noise

Ripple and noise is defined as periodic or random signals over a frequency range of 10Hz to 20MHz. Measurements are to be made with an 20MHz bandwidth oscilloscope. Measurements are taken at the end of a 150mm length of a twisted pair of cables, terminated with a 100nF ceramic capacitor and a 120μF electrolytic capacitor. The earth wire of the oscilloscope probe should be as short as possible, winding a link wire around the earth collar of the probe is the preferred method.

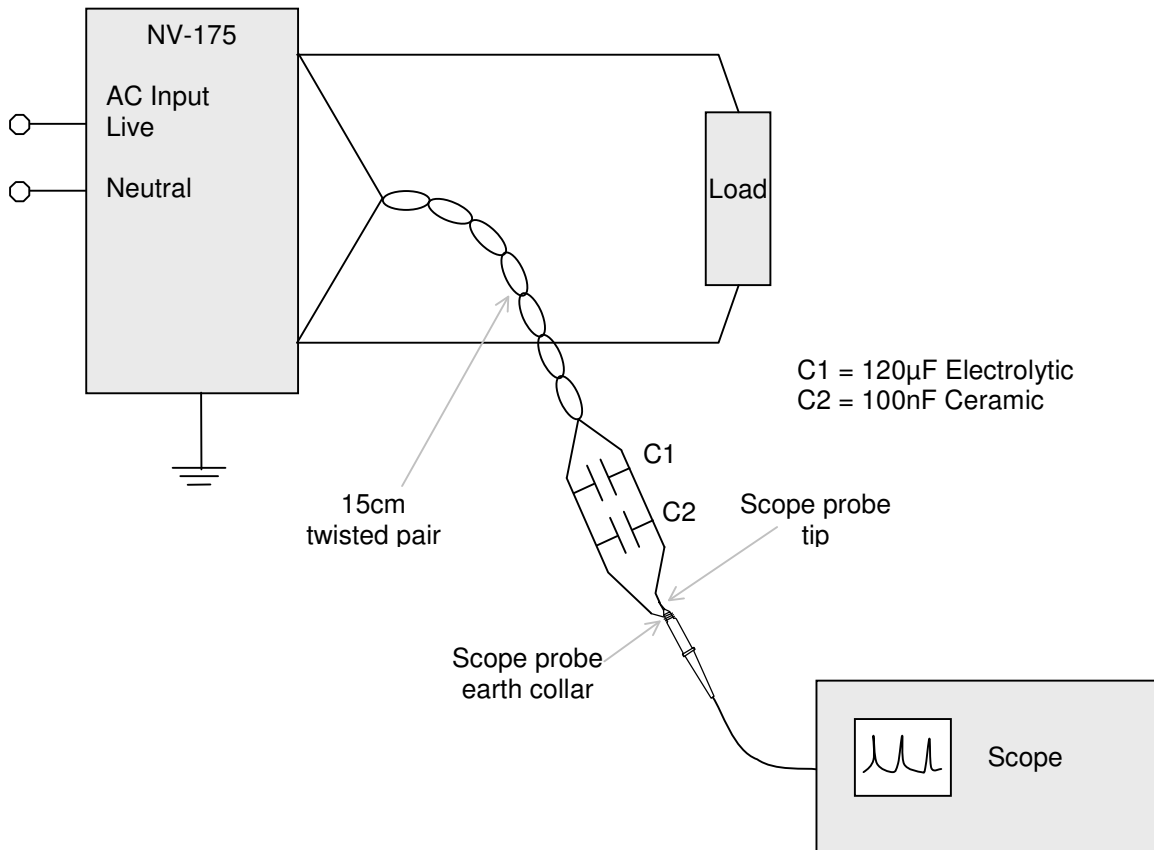
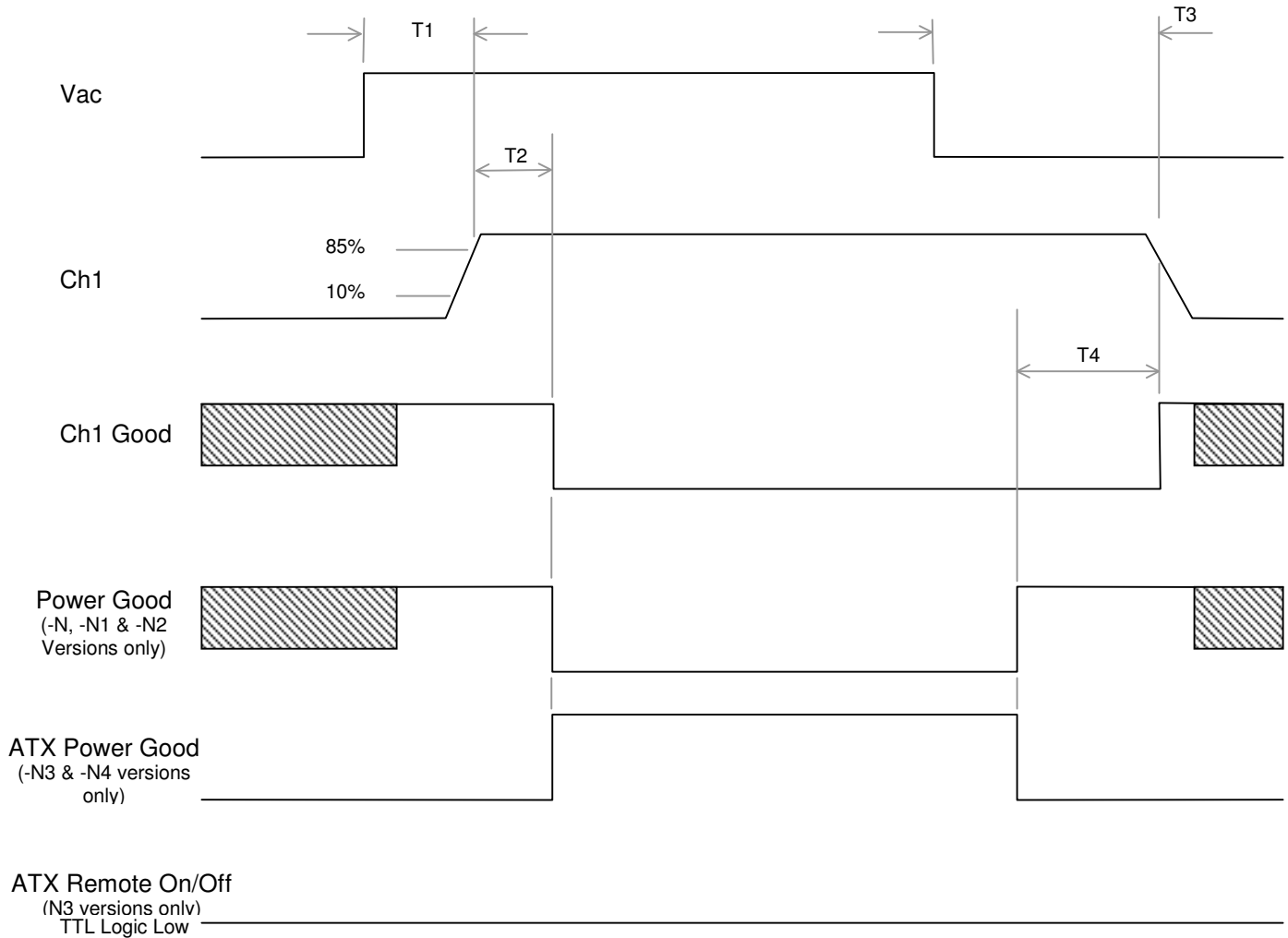

Figure 3: RIPPLE AND NOISE MEASUREMENT METHOD

+5/+3.3V POWER SEQUENCING FOR NV-175

The +5V output level is equal to or greater than the +3.3V output at all times during power up and normal operation.

POWER SUPPLY TIMING



	min	Typical	max	Description
T1			1.5s	Turn on time
T2	200ms		500ms	Output good hold off time
T3	16ms			Hold up time
T4	5ms			Power good warning time

Figure 4: Output timing diagram

POWER SUPPLY TIMING (-N3 & -N4 Versions)

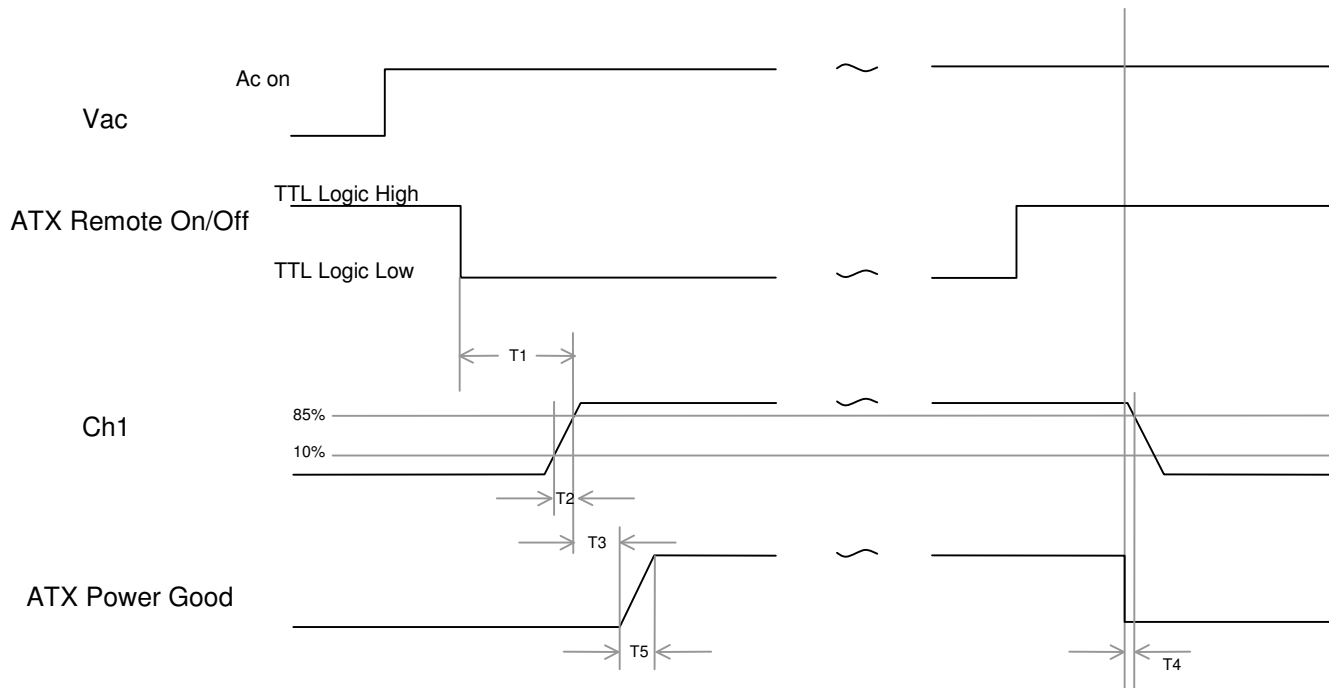

	min	max	Description
T1		500ms	Power-on time (enable to Ch1 in regulation)
T2	0.1ms	20ms	Ch1 rise time
T3	100ms	500ms	ATX Power Good delay
T4	1ms		Power down warning
T5		10ms	ATX Power Good risetime

Figure 5: ATX Signal timing diagram (-N3 & -N4 Versions)

SIGNALS

Important note: The pin numbers referenced in this section relate to the standard output connector version. For pin numbering of the right angled output connector variant, please see the “Pin Definition” section.

STANDBY SUPPLY (+ Output) (J1-12)

STANDBY SUPPLY 0V (return) (J1-24)

See table below for full details. If the table suggests Isolated then the output is isolated from the other output channels. If the table states Common then the 0V of the standby supply is common with the 0V of the other outputs.

Option	Standby Supply		Isolated or common 0V
	Voltage	Current	
-N	5V	2A	Isolated
-N1	12V	1A	Isolated
-N2	13.5V	1A	Isolated
-N3	5V	2A	Common
-N4	12V	1A	Common

POWER GOOD SIGNAL (J1-11) (available on ‘-N’, ‘-N1’ or ‘-N2’ versions only.)

The Power Good signal is an open collector output that is low to indicate that the ac supply is good and that

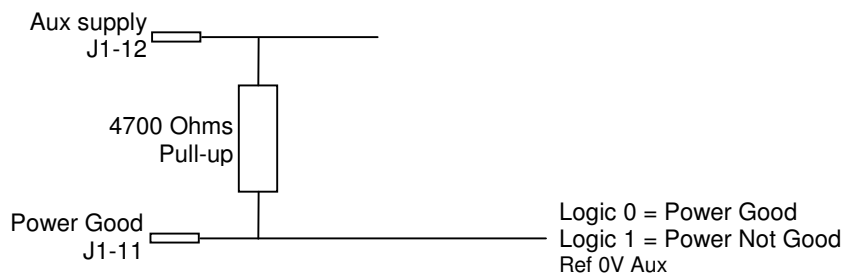

Figure 6: Example use of ‘Power Good’

output 1 is operating within its regulation limits. It is delayed after start-up to ensure that sufficient primary side energy is stored by the power supply for continuous power operation within the specified hold-up time. When the AC power is removed the Power Good Signal will go to an open circuit state. The specifications for the Power Good Signal are contained below

Signal Type	Open collector output. Emitter connected to CH1 0V.
Maximum Current	5mA
Maximum voltage (collector to 0V)	30V
Logic low (when signal is turned on)	<0.4V when sinking 5mA

ATX POWER GOOD SIGNAL (J1-11) (available on ‘-N3’ and ‘-N4’ versions only.)

The Power Good signal shows logic high to indicate that the ac supply is good and that output 1 is operating within its regulation limits. It is delayed after start-up to ensure that sufficient primary side energy is stored by the power supply for continuous power operation within the specified hold-up time. When the AC power is removed the Power Good Signal will go to a logic low state. The specifications for the Power Good Signal are contained below.

Signal Type	+5V TTL compatible
Logic Level Low	< 0.4V while sinking 4mA

Logic Level High	Between 2.4 VDC and 5VDC output while sourcing 200 μ A
High State Output Impedance	1kOhm from output to common
ATX Power Good delay	100ms < T ₃ < 500ms
ATX Power Good rise time	T ₅ \leq 10ms
Power down warning	T ₄ > 1ms

Note: No additional pull up resistor is required for this signal.

CH1 POWER GOOD – CHANNEL 1 GOOD (J1-22)

The Channel 1 Good signal is an open collector output which is turned on to indicate that output 1 is operating within its regulation limits. It is delayed after start-up to ensure that sufficient primary side energy is stored by the power supply for continuous power operation for the specified hold-up time. When Channel 1 falls to below 85% of nominal, the Channel 1 Good Signal will go to an open circuit state. The specifications for the Channel 1 Good Signal are contained below

Signal Type	Open collector output. Emitter connected to CH1 0V.
Maximum Current	5mA
Maximum voltage (collector to 0V)	30V
Logic low (when signal is turned on)	<0.4V when sinking 5mA

REMOTE ON/OFF – GLOBAL ON/OFF (J1-23) (available on '-N', '-N1' and '-N2' versions

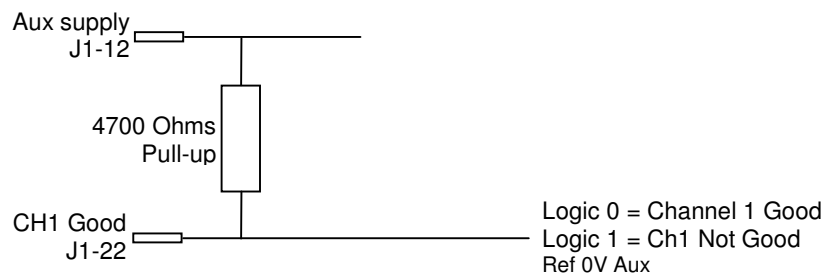

Figure 7: Example use of 'Channel 1 Good'

only.)

A TTL logic level high (referenced to Standby Return) will inhibit all outputs (except Standby).

Maximum input voltage – 5V

Maximum current required for Logic High – 1mA

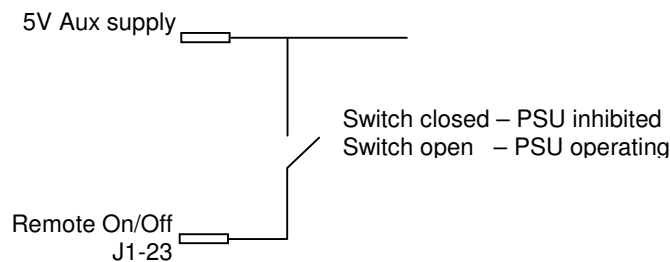

Figure 8: Example use of 'Remote On/Off'

ATX REMOTE ON/OFF – GLOBAL ON/OFF (J1-23) (available on ‘-N3’ and ‘-N4’ versions only.)

A TTL logic level high or open circuit will inhibit all outputs (except Standby).

Maximum input voltage – 5V

Maximum current required for Logic High – 1mA

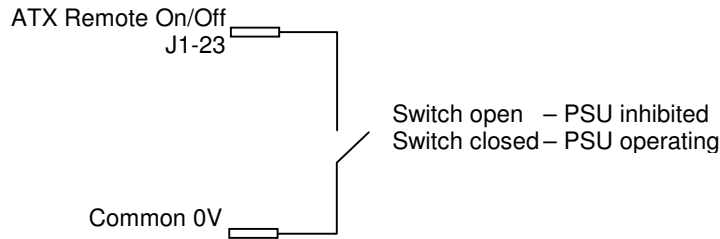

Figure 9: Example use of ‘ATX Remote On/Off’

OVERSHOOT AT TURN ON/OFF

The output voltage overshoot upon the application or removal of the input mains voltage shall be less than 10% above the nominal voltage. No voltage of opposite polarity shall be present on any output during turn on or turn off.

OUTPUT PROTECTION

Over temperature protection

If the NV-175 is operated without adequate cooling, it will cause an over temperature condition and the power supply will shut down. To restart the PSU, remove the ac supply for 2 seconds and then reapply.

Over voltage protection

An overvoltage on CH1, 2 or 3 will cause the whole power supply to shutdown (except for standby supply, when fitted). To restart the PSU, remove the ac supply for 10 seconds and then reapply.

Short-Circuit Protection

A short circuit is defined as an impedance of <math><0.1\text{ Ohms}</math> placed between the DC return and any output. A short circuit will cause no damage to the power supply and will cause it to shutdown. The power supply will attempt to restart every 150ms (approximately) until the short-circuit is removed. After removal of the short circuit, the power supply will maintain normal operation.

A short circuit on the CH4 output will not cause the power supply to shut down; however, after the short circuit is removed, the CH4 output will resume normal operation.

Overcurrent Protection

Overload currents applied to each output will cause the output to trip before reaching or exceeding the SELV level of 240VA.

No Load Operation

The power supply will operate with no load on all outputs with no damage, hazardous condition or reduction in performance.

COOLING REQUIREMENTS

Forced Air Cooling

The maximum continuous rating of all DC outputs combined is 175Watts with a minimum of 2m/s of forced-air cooling across the power supply. The recommended air flow direction is from input to output.

Natural Convection

Under the following load conditions, output power is reduced to 75 Watts with unrestricted natural convection cooling and an ambient temperature of 40°C or less. The power distribution across outputs will affect the available output power.

Output	Voltage (V)	Load (A)	Power (W)
Ch1	5	11	55
Ch2	3.3	2.5	8.25
Ch3	15	0.6	9
Ch4	15	0.2	3
			75.25

TEMPERATURE DERATING

NV-175 achieves full power output up to 50 °C. Above this temperature, the total output power (and individual output currents) must be derated by 2.5%/°C up to 70 °C. See diagram below.

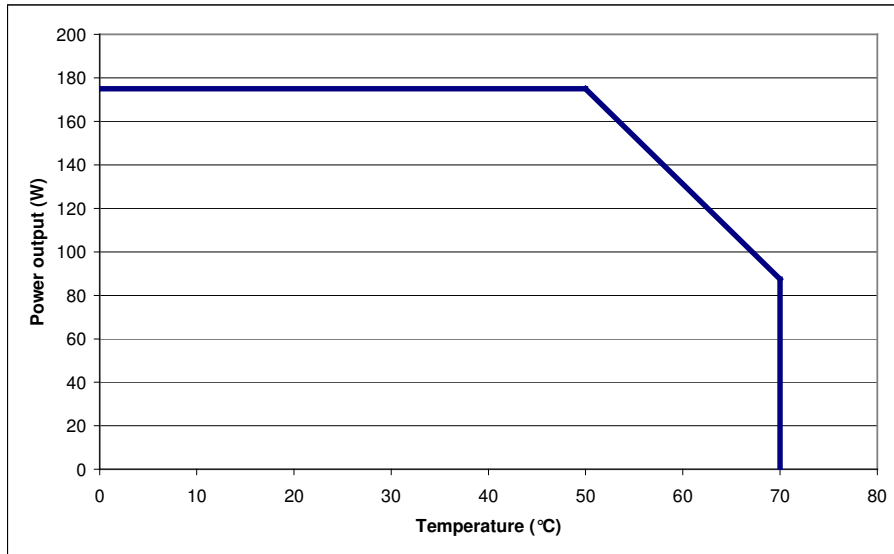

Figure 10: NV-175 Thermal Derating curve

ELECTROMAGNETIC COMPATIBILITY

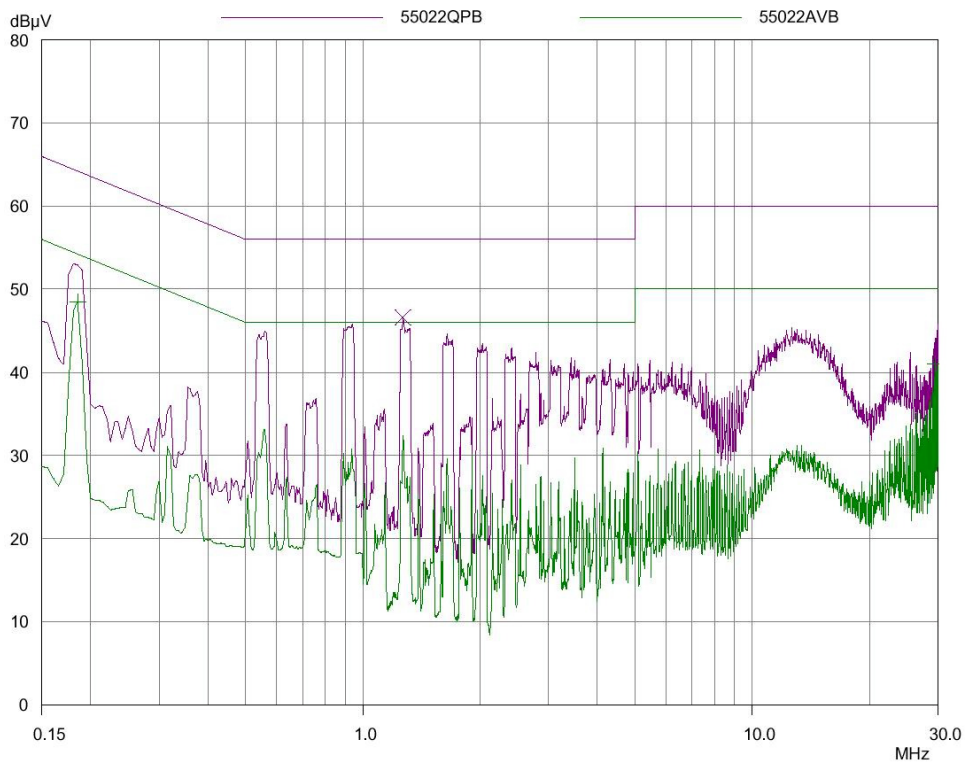

Figure 11: Sample plot of NV1-453TT-N2
 Measured at 230V input, 5V 17A, 3.3V 6A, 12V 2A, -12V 1A

Installation for optimum EMC performance

Mounting

All equipment should be mounted inside an earthed metal box.

If this is not possible then use an earthed metal plane to mount the power supply and load.

All 4 corners (of the uncased unit) should be connected to earth.

Cables

All cables (both ac input and dc output) should be run as close as possible to the earthed metal box/plane.

AC input cable should be twisted group laid as flat to the earthed metal box/plane as possible.

All output cables should be routed as far away from input cables as possible.

If the input and output cables must be run close to each other then screen one or other (or ideally both).

The positive and negative supply cables should be twisted together.

The remote sense wires (if used) should be twisted together and run alongside their related supply cables.

All cable run loops should be kept as small as possible (this should be implemented in PCB design also).

Connecting between boxes

If cables must be connected between equipment boxes then at the closest possible point to the port where the cables exit the 1st enclosure connect 100nF decoupling Y caps (between the output and earth). Note that these capacitors must be rated at the working voltage. Ideally these capacitors should be between all signal cables which have to connect between boxes although this may not be practical if fast switching [digital] signals are involved (if this is the case then smaller value Y capacitors should be used).

Earth star point

Where the ac supply enters the equipment, this should be taken to a 'star point' chassis mounted earth point (Note compliance with EN609050 practices which require own star point washer and nut) as close as possible to the IEC inlet. All other earth points should be taken back to this point only.

RELIABILITY

Calculated using Telcordia Issue 1, Case 3

FPMH (Failures per million hours)

Temperature	0 °C	30 °C	40 °C	50 °C	60 °C	70 °C
Main Assembly	0.548	1.267	1.703	2.319	3.205	4.498
Channel 2	0.102	0.256	0.356	0.496	0.695	0.975
Channel 3	0.066	0.152	0.208	0.287	0.401	0.567
Channel 4 ('xH' type)	0.075	0.147	0.190	0.249	0.334	0.457
Channel 4 (Linear)	0.001	0.020	0.039	0.074	0.136	0.240
Primary Option	0.054	0.307	0.541	0.958	1.705	3.028
Fan	2.396	1.941	3.067	4.845	7.656	12.096

To calculate MTBF, sum the FPMH for all component parts at the required temperature. This gives total failures per million hours (FPMH). Convert this to MTBF by dividing 1000000 by the FPMH.

For example: -

Require the MTBF for NV1-453TT at 30 °C

Main Assembly	1.267
Channel 2	0.256
Channel 3	0.152
Channel 4	0.020

Total FPMH 1.695

Therefore MTBF = $1000000 / 1.695 = 589970$ hours (590k hours)

CONNECTION

Input

Input housing is Molex part number 09-50-8051 (or equivalent part from alternative manufacturer)
 The Molex part number for the crimps is 08-52-0113 (or equivalent part from alternative manufacturer)
 25 housings and 75 crimps are available as a single part number from TDK-Lambda. The part number is 94910.

Output

Output housing is Molex part number 39-01-2245 (or equivalent part from alternative manufacturer)
 The Molex part number for the crimps is 44476-3112 (or equivalent part from alternative manufacturer)
 25 housings and 600 crimps are available as a single part number from TDK-Lambda. The part number is 94911.

Pin Definition (standard [vertical] output connector)

Pin	Channel	Function
J1-1	3	+ Output
J1-2	2	Positive sense
J1-3	2	+ Output
J1-4	2	+ Output
J1-5	Common	0V (DC Return)
J1-6	Common	0V (DC Return)
J1-7	1	Positive sense
J1-8	1	+ Output
J1-9	1	+ Output
J1-10	1	+ Output
J1-11		Power good – only on ‘-N’, ‘-N1’ and ‘-N2’ versions. ATX Power good – only on ‘-N3’ and ‘-N4’ versions.
J1-12	Standby	Standby output (+ Output), channel 5, ‘-N’, ‘-N1’, ‘-N2’, ‘-N3’ and ‘-N4’ versions only
J1-13	4	- Output
J1-14	2	Negative sense
J1-15	2	+ Output
J1-16	Common	0V (DC Return)
J1-17	Common	0V (DC Return)
J1-18	Common	0V (DC Return)
J1-19	1	Negative sense
J1-20	1	+ Output
J1-21	1	+ Output
J1-22		Channel 1 good
J1-23		Remote On/Off – only on ‘-N’, ‘-N1’ and ‘-N2’ versions. ATX Remote On/Off – only on ‘-N3’ and ‘-N4’ versions.
J1-24	Standby 0V	Standby return – isolated on ‘-N’, ‘-N1’ and ‘-N2’ versions. - Common 0V on ‘-N3’ and ‘-N4’ versions.

Pin Definition (variants fitted with right angled output connector)

Pin	Channel	Function
J1-1	Standby 0V	Standby return – isolated on ‘-N’, ‘-N1’ and ‘-N2’ versions. - Common 0V on ‘-N3’ and ‘-N4’ versions.
J1-2		Remote On/Off – only on ‘-N’, ‘-N1’ and ‘-N2’ versions. ATX Remote On/Off – only on ‘-N3’ and ‘-N4’ versions.
J1-3		Channel 1 good
J1-4	1	+ Output
J1-5	1	+ Output
J1-6	1	Negative sense
J1-7	Common	0V (DC Return)
J1-8	Common	0V (DC Return)
J1-9	Common	0V (DC Return)
J1-10	2	+ Output
J1-11	2	Negative sense
J1-12	4	Output (+ or -, depending on model)
J1-13	Standby	Standby output (+ Output), channel 5, ‘-N’, ‘-N1’, ‘-N2’, ‘-N3’ and ‘-N4’ versions only
J1-14		Power good – only on ‘-N’, ‘-N1’ and ‘-N2’ versions. ATX Power good – only on ‘-N3’ and ‘-N4’ versions.
J1-15	1	+ Output
J1-16	1	+ Output
J1-17	1	+ Output
J1-18	1	Positive sense
J1-19	Common	0V (DC Return)
J1-20	Common	0V (DC Return)
J1-21	2	+ Output
J1-22	2	+ Output
J1-23	2	Positive sense
J1-24	3	+ Output

IMPORTANT NOTE

Note revised pin numbering for J2. Previous documents (Application note Version 1.0 or earlier, datasheet revision 7.0 [June05] or earlier and handbook version 5 or earlier) used a numbering system that was different from Molex. New releases have rectified this. Mechanically and electrically, the connection is the same. See table below for details.

Pin	Function	Previous	Molex
J2-1	Earth – chassis/safety ground	J2-5	J2-1
J2-2	Do not connect	J2-4	J2-2
J2-3	Live	J2-3	J2-3
J2-4	Do not connect	J2-2	J2-4
J2-5	Neutral	J2-1	J2-5

MOUNTING

The NV-175 can be mounted in any orientation but must be mounted on all four corners.

‘-C’ (covered) and ‘-U’ (U chassis) versions to be mounted using all four fixings on the bottom of the unit or the fixing holes on the side of the unit.

Uncovered versions should be mounted on stand-offs that are at least 6.35mm tall.

WEIGHTS

NV-175 (quad output, open frame)	0.30 kg
NV-175 (with global option)	0.40 kg
NV-175 (with cover + chassis)	0.40 kg
NV-175 (with global option + cover + chassis)	0.50 kg
NV-175 (with global option + cover + chassis + fan +IEC inlet)	0.60 kg

TEST RESULTS

Detailed test results are available online from: -

<http://testcert.emea.tdk-lambda-europe.com/>

You will need the serial number and product code of the unit to retrieve the test results for the unit. Test results will not be packaged with the unit. This ensures that the test results will be available for the NV-Power unit for the whole life of the power supply (not just when the unit is unpacked as with the more traditional printed test results).