

3 Port Direct Operated Solenoid Valve Rubber Seal

Series SY100

Specifications

Fluid	Air
Ambient and fluid temperature (°C)	-10 to 50°C (No freezing. Refer to page 4-18-4.)
Response time (ms) ⁽¹⁾	10 or less
Max. operating frequency (Hz)	20
Manual override	Non-locking push type, Locking slotted type Push-turn locking slotted type Push-turn locking lever type (SY1 $\frac{3}{4}$, SY1 $\frac{3}{4}$ A only)
Lubrication	Not required
Mounting position	Unrestricted
Impact/Vibration resistance (m/s ²) ⁽²⁾	150/30
Enclosure	Dustproof



Body ported

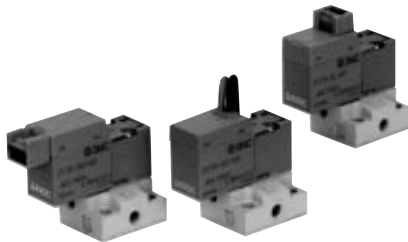

Base mounted

Note 1) Based on dynamic performance test, JIS B 8374-1981. (Coil temperature: 20°C, at rated voltage, without surge suppressor.)
 Note 2) Impact resistance: No malfunction occurred when it is tested with a drop tester in the axial direction and at the right angles to the main valve and armature in both energized and de-energized states every once for each condition. (Values at the initial period)
 Vibration resistance: No malfunction occurred in a one-sweep test between 45 and 2000 Hz. Test was performed at both energized and de-energized states in the axial direction and at the right angles to the main valve and armature. (Values at the initial period)

Solenoid Specifications

Series		SY1 $\frac{3}{4}$ ₂₄	SY1 $\frac{3}{4}$ ₂₄ A
Electrical entry		Grommet (G)/(H), L plug connector (L) M plug connector (M)	
Coil rated voltage (V)	DC	24, 12, 6, 5, 3	
	AC 50/60 Hz	100, 110, 200, 220	—
Allowable voltage fluctuation		-10 to +10%	
Power consumption (W)	DC	0.5 (With indicator light: 0.55)	0.75 W (With indicator light: 0.8 W)
Apparent power (VA)	AC	100 V	0.9 (With indicator light: 1.0)
		110 V	1.0 (With indicator light: 1.1)
		[115 V]	[1.1 (With indicator light: 1.2)]
		200 V	1.8 (With indicator light: 1.9)
		220 V [230 V]	[1.9 (With indicator light: 2.0) [2.2 (With indicator light: 2.3)]
Surge voltage suppressor		Diode	
Indicator light		LED	

* It is in common between 110 VAC and 115 VAC, and between 220 VAC and 230 VAC.
 [Low wattage [0.45 W] is available, too. For details, refer to catalog on page 4-18-4.]

JIS Symbol

SY11 $\frac{3}{4}$ (A)

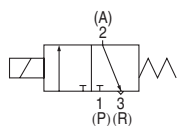

SY12 $\frac{3}{4}$ (A)

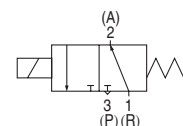

Made to Order Specifications
 (For details, refer to page 4-3-17.)

Model

Function	Valve model	Type	Operating pressure range (MPa)	Vacuum specifications (MPa)		Port size		Effective area (mm ²)	Weight (g) ⁽²⁾	
				1(P) port	3(R) port	1(P), 3(R) port	2(A) port		Grommet	L plug connector, M plug connector
N.C.	SY11 $\frac{3}{4}$	Standard	0 to 0.7	-100 kPa to 0.6	-100 kPa to 0	M3 x 0.5	M3 x 0.5	0.14	SY1□3(A): 13 SY1□4(A): 24 (12)	SY1□3(A): 15 SY1□4(A): 26 (14)
N.C.	SY11 $\frac{3}{4}$ A	Large flow	0 to 0.7	-100 kPa to 0.6	-100 kPa to 0	M3 x 0.5	M3 x 0.5	0.22		
N.O.	SY12 $\frac{3}{4}$ ⁽¹⁾	Standard	0 to 0.7	-100 kPa to 0	-100 kPa to 0.6	M3 x 0.5	M3 x 0.5	0.14		
N.O.	SY12 $\frac{3}{4}$ A ⁽¹⁾	Large flow	0 to 0.7	-100 kPa to 0	-100 kPa to 0.6	M3 x 0.5	M3 x 0.5	0.22		

Note 1) SY123/SY124 $\frac{3}{4}$ and SY123/SY124 $\frac{3}{4}$ A: Supply pressure to 1(R) port and exhaust air from 3(P) port.
 Note 2) Value for DC. Add 1 g for AC. (): Without sub-plate.

How to Order

Standard type (Cv0.008)

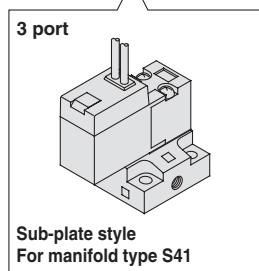
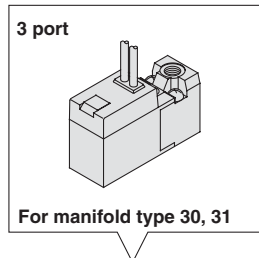

Type of actuation

1	Normally closed
2	Normally open

Rated voltage

For DC	
5	24 VDC
6	12 VDC
V	6 VDC
S	5 VDC
R	3 VDC

For AC (50/60 Hz)	
1	100 VAC
2	200 VAC
3	110 VAC [115 VAC]
4	220 VAC [230 VAC]

Light/Surge voltage suppressor

Nil	Without light/surge voltage suppressor
S	With surge voltage suppressor
Z	With light/surge voltage suppressor
R	With surge voltage suppressor (Non-polar type)
U	With light/surge voltage suppressor (Non-polar type)

* For AC voltage valves there is no "S" option. It is already built into the rectifier circuit.
* For "R" and "U", DC voltage is only available.

Porting specifications

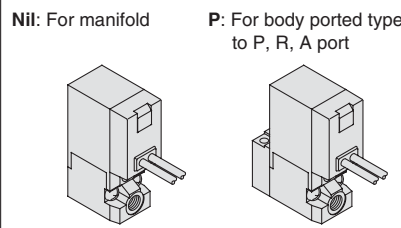

Bracket

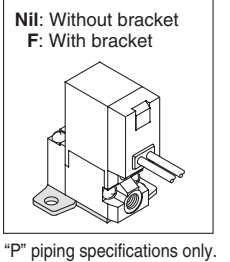

Port size

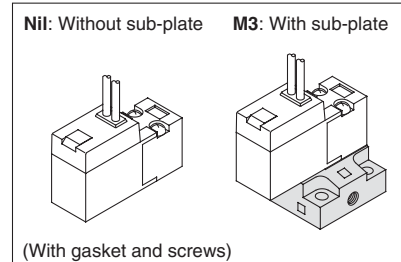

Electrical entry

24 V, 12 V, 6 V, 5 V, 3 VDC/100 V, 110 V, 200 V, 220 VAC			
Grommet	L plug connector	M plug connector	
G: 300 mm lead wire	L: With lead wire (Length 300 mm)	M: With lead wire (Length 300 mm)	MN: Without lead wire
H: 600 mm lead wire	LN: Without lead wire	LO: Without connector	MO: Without connector

* "LN" and "MN" types are with 2 sockets.

Manual override

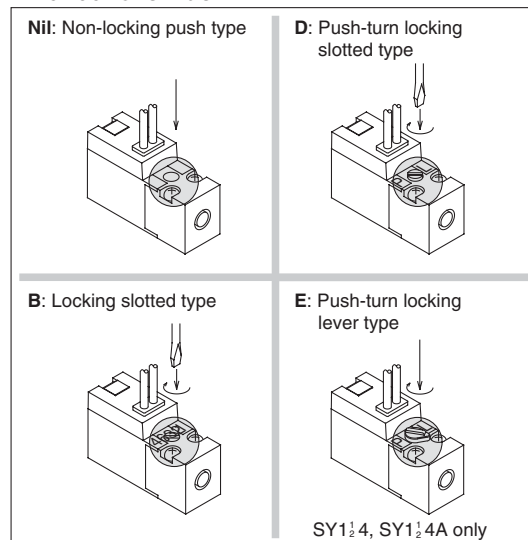

- V100
- SY**
- SYJ
- VK
- VZ
- VT
- VP
- VG
- VP
- S070
- VQ
- VKF
- VQZ
- VZ
- VS
- VFN

How to Order

Large flow type (Cv: 0.012)

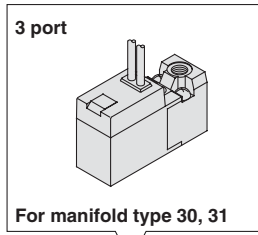

Large flow type
(Cv: 0.012) : Body ported

SY1 1 3 A — 5 L [] [] [] M3 []

Large flow type
(Cv: 0.012) : Base mounted

SY1 1 4 A — 5 M [] [] []

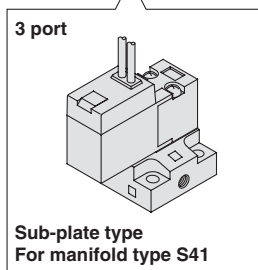

Rated voltage

5	24 VDC
6	12 VDC
V	6 VDC
S	5 VDC
R	3 VDC

Large flow type

Light/Surge voltage suppressor

Nil	Without light/surge voltage suppressor
S	With surge voltage suppressor
Z	With light/surge voltage suppressor
R	With surge voltage suppressor (Non-polar type)
U	With light/surge voltage suppressor (Non-polar type)

Porting specifications

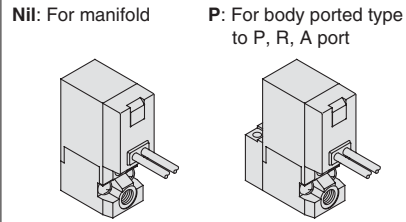

Bracket

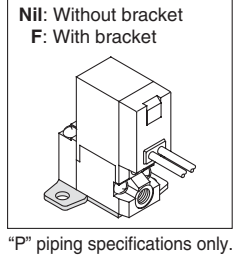

Port size

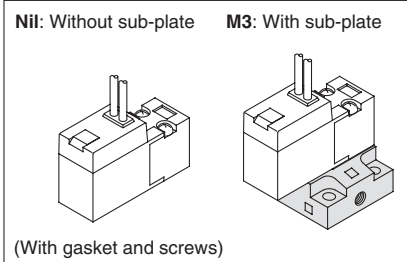

Electrical entry

24 V, 12 V, 6 V, 5 V, 3 VDC			
Grommet	L plug connector	M plug connector	
G: 300 mm lead wire	L: With lead wire (Length 300 mm)	M: With lead wire (Length 300 mm)	MN: Without lead wire
H: 600 mm lead wire	LN: Without lead wire	LO: Without connector	MO: Without connector

* "LN" and "MN" types are with 2 sockets.

Manual override

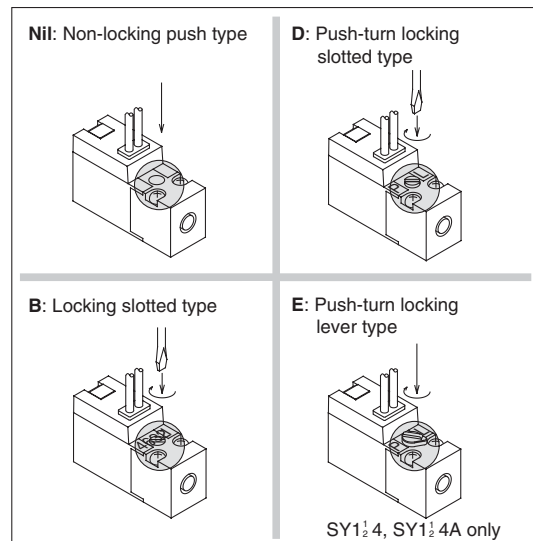

Construction

SY114, SY114A

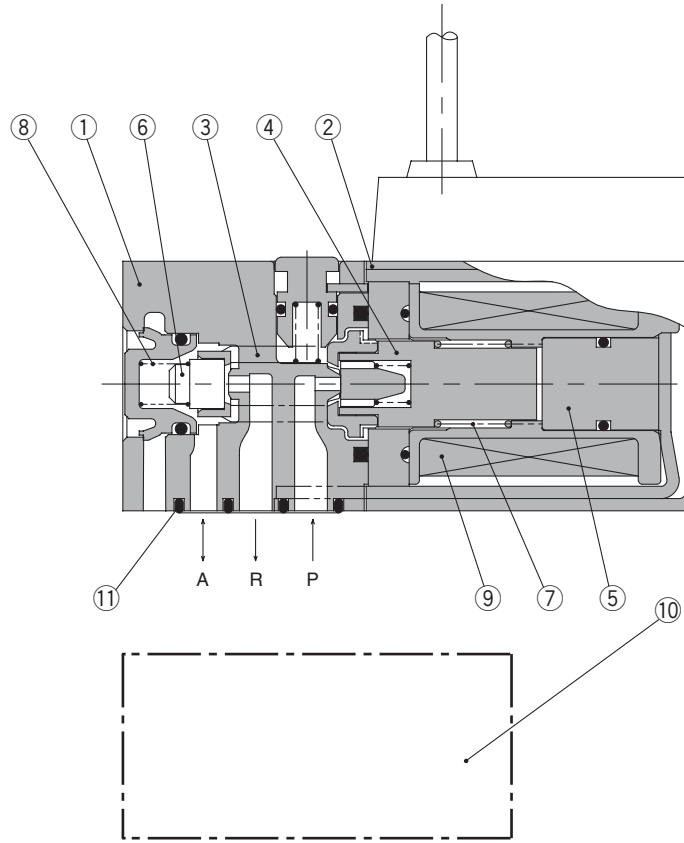
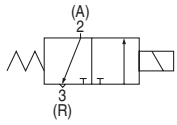

- V100
- SY**
- SYJ
- VK
- VZ
- VT
- VP
- VG
- VP
- S070
- VQ
- VKF
- VQZ
- VZ
- VS
- VFN

Component Parts

No.	Description	Material	Note
①	Body	Resin	Gray
②	Cover	Resin	Gray
③	Push rod	Resin	—
④	Movable iron core assembly	HNBR/Stainless steel	—
⑤	Fixed iron core	Stainless steel	—
⑥	Exhaust poppet	HNBR	—
⑦	Return spring	Stainless steel	—
⑧	Poppet spring	Stainless steel	—
⑨	Coil assembly	—	—

Replacement Parts

No.	Description	Part no.	Material
⑩	Sub-plate	SY100-74-1	Zinc die-casted
⑪	Gasket	VJ100-6-8	HNBR

How to Order Connector Assembly

- For DC: **SY100-30-4A**
- For 100 VAC: **SY100-30-1A**
- For 200 VAC: **SY100-30-2A**
- For other voltages of AC: **SY100-30-3A**

Without lead wire: **SY100-30-A**
 (With connector and 2 pcs. of socket)

●Lead wire length

Nil	300 mm
6	600 mm
10	1000 mm
15	1500 mm
20	2000 mm
25	2500 mm
30	3000 mm
50	5000 mm

Series SY100

Body Ported

Grommet (G), (H): SY1₂¹3 (A)-□_H□□-PM3(-F)

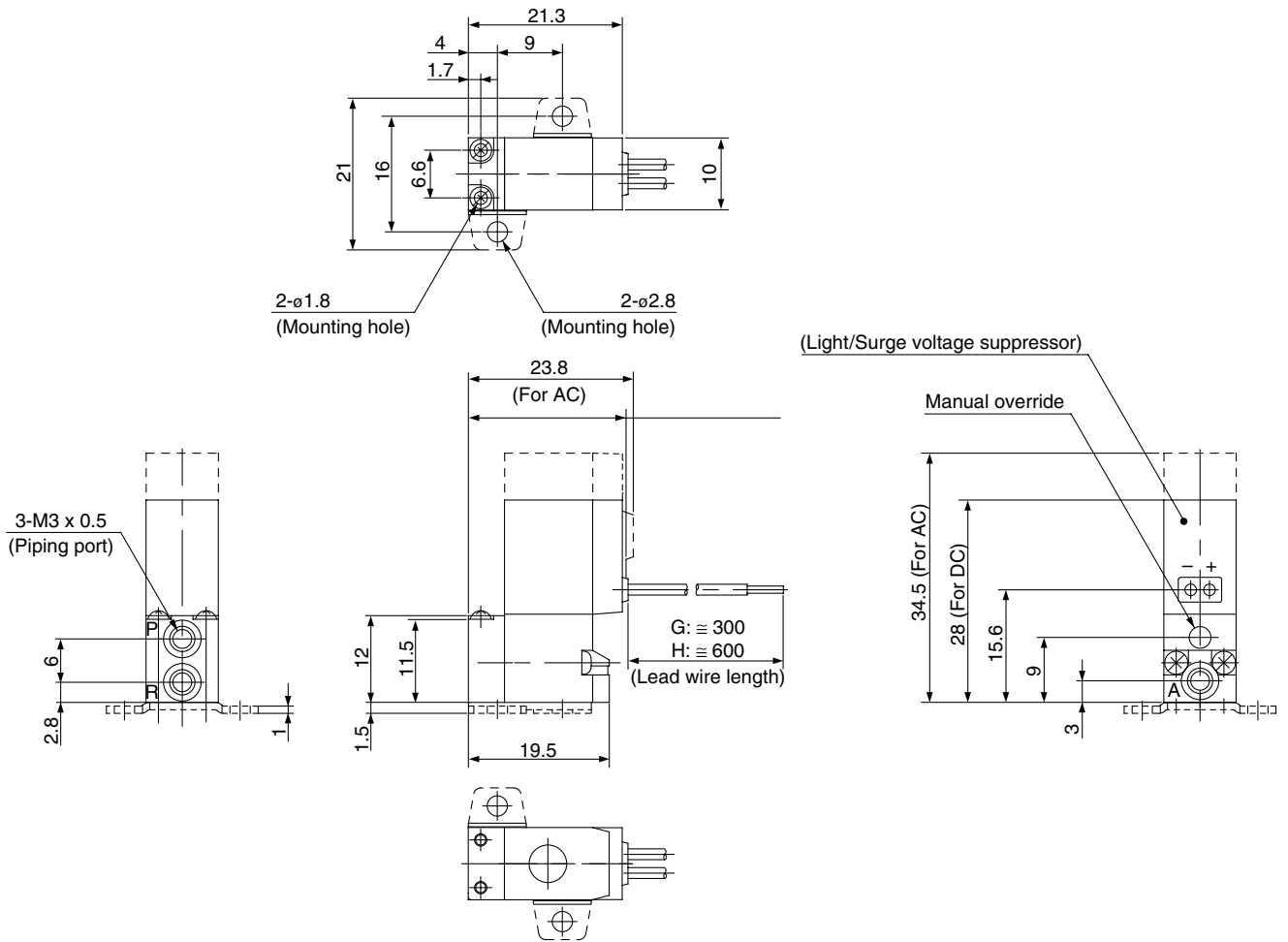

L plug connector (L): SY1₂¹3(A)-□L□□-PM3(F)

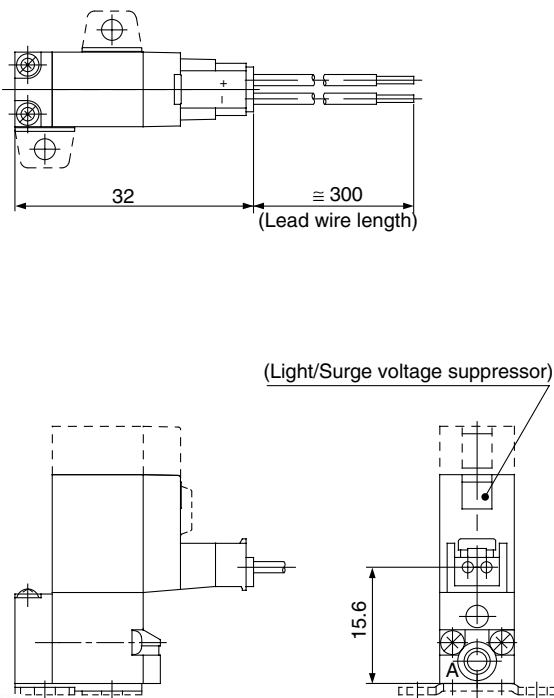

M plug connector (M): SY1₂¹3(A)-□M□□-PM3(-F)

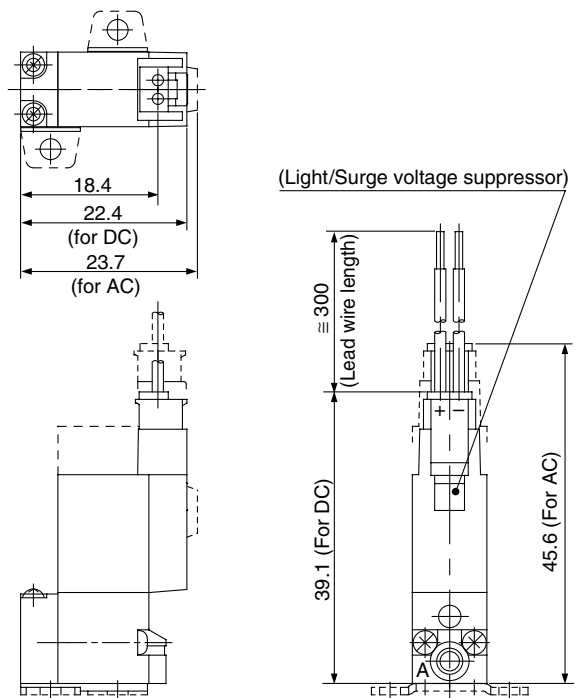

* Other dimensions are same as grommet type.

* Other dimensions are same as grommet type.

Base Mounted (With sub-plate)

Grommet (G), (H): SY1 $\frac{1}{2}$ 4(A)-□^G_H□□-M3

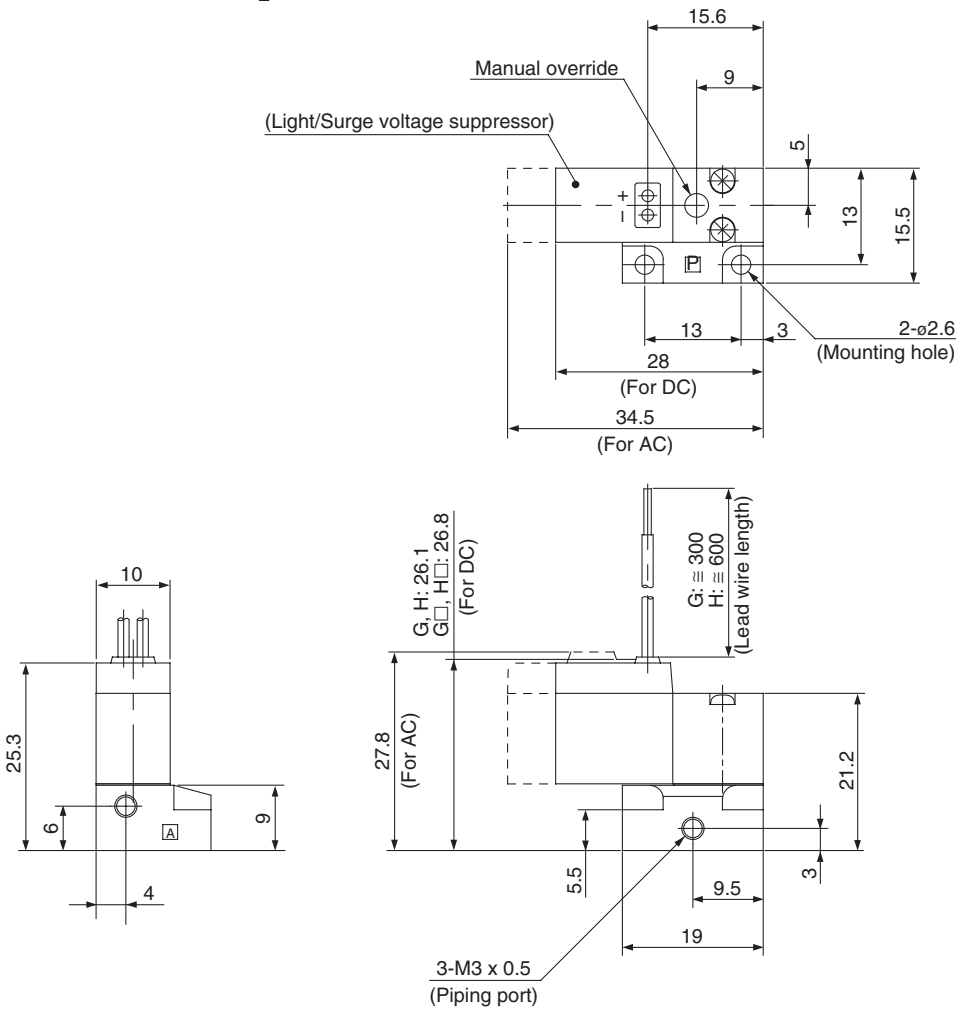

- V100
- SY**
- SYJ
- VK
- VZ
- VT
- VP
- VG
- VP
- S070
- VQ
- VKF
- VQZ
- VZ
- VS
- VFN

L plug connector (L): SY1 $\frac{1}{2}$ 4(A)-□L□□-M3

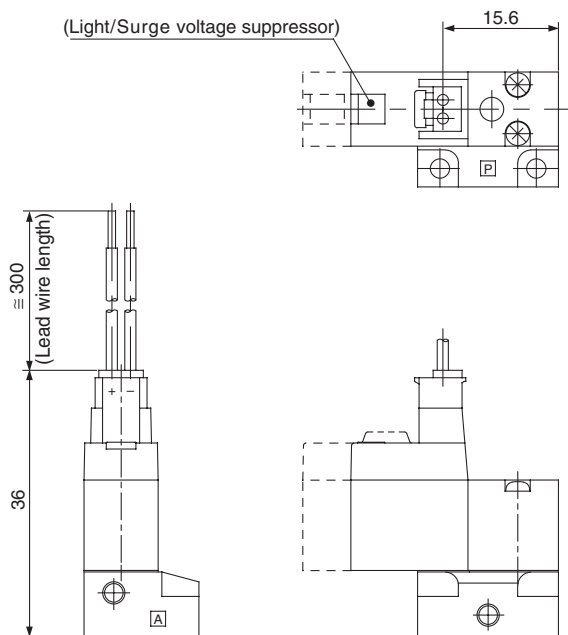

 * Other dimensions are same as grommet type.

M plug connector (M): SY1 $\frac{1}{2}$ 4(A)-□M□□-M3

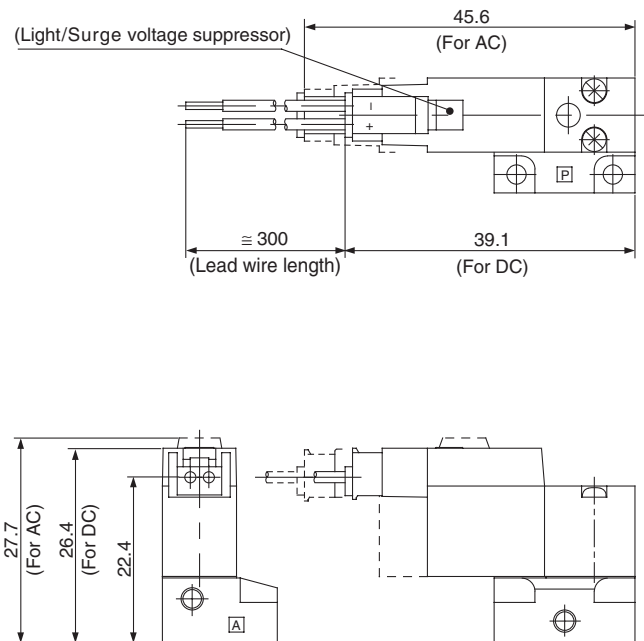

 * Other dimensions are same as grommet type.

Series SY

Made to Order Specifications:

Please contact SMC for detailed specifications, delivery and pricing.

Energy-saving Type

Power consumption is decreased by 1/3 by reducing the wattage required to hold the valve in an energized state. (Effective energizing time is over 62 ms at 24 VDC.)

Specifications

Series		SY1 ¹ ₂ ³ ₄ T	SY1 ¹ ₂ ³ ₄ AT
Coil rated voltage (V)		24 DC, 12 DC	
Power consumption (W)	Inrush	0.55	0.8
	Holding	0.22	0.3

Specifications other than above are the same as standard models.

How to Order

Body ported SY1 1 3 T-5 L Z M3-

Base mounted SY1 1 4 T-5 M Z

Type of actuation

1	Normally closed
2	Normally open

Body option

Nil	Standard
A	Large flow capacity

Rated voltage

5	24 VDC
6	12 VDC

• Entry is the same as standard products.

Working Principle

The circuit shown below reduces current consumption at holding which reduces the overall power consumption. Refer to electrical power waveform as shown below.

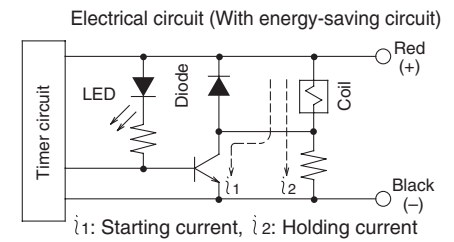

<Energy-saving Type, Electrical Power Waveform for SY1¹₂³₄T>

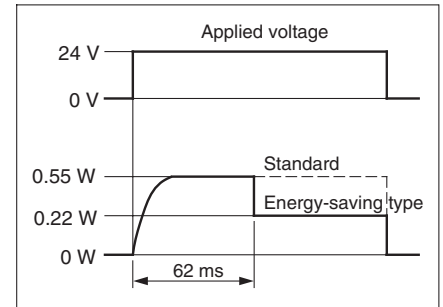

<Energy-saving Type, Electrical Power Waveform for SY1¹₂³₄AT>

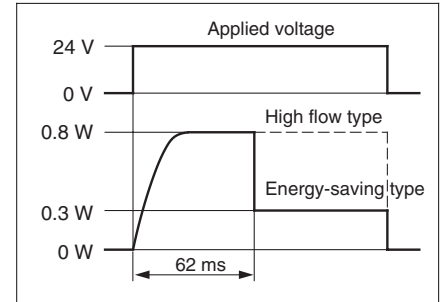

Low Wattage Specifications (0.45 W)

How to Order

SY1 - - X200

• Entry is the same as standard products.

V100

SY

SYJ

VK

VZ

VT

VP

VG

VP

S070

VQ

VKF

VQZ

VZ

VS

VFN