

Analog Devices Welcomes Hittite Microwave Corporation

NO CONTENT ON THE ATTACHED DOCUMENT HAS CHANGED



THIS PAGE INTENTIONALLY LEFT BLANK



GaAs MMIC POSITIVE CONTROL T/R SWITCH, DC - 6 GHz

Typical Applications

The HMC536MS8G / HMC536MS8GE is ideal for:

- Cellular/PCS/3G Infrastructure
- ISM/MMDS/WiMAX
- CATV/CMTS
- Test Instrumentation

Features

- Input P0.1dB: +34 dBm @ +5V
- Insertion Loss: 0.5 dB
- Positive Control: +3V or +5V
- MS8G SMT Package, 14.8 mm²
- Isolation: 27 dB
- Very Fast Switching Speed
- Included in the HMC-DK005 Designer's Kit

Functional Diagram

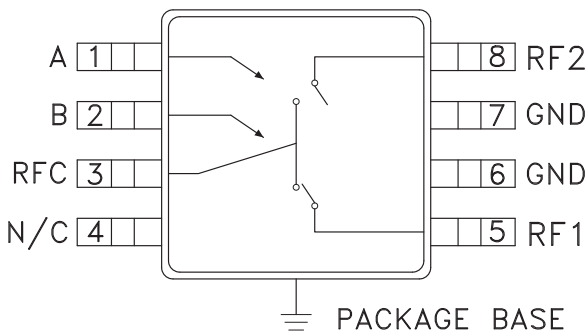

General Description

The HMC536MS8G & HMC536MS8GE are DC to 6 GHz GaAs MMIC T/R switches in 8 lead MSOP8G surface mount packages with an exposed ground paddle. The switch is ideal for cellular/PCS/3G basestation applications featuring low 0.5 dB insertion loss and +55 dBm input IP3. Power handling is excellent up through 6 GHz with the switch offering a P0.1dB compression point of +29 dBm at +3 volts control. On-chip circuitry allows positive voltage control of 0/+3 volts or 0/+5 volts at very low DC currents.

Electrical Specifications, $T_A = +25^\circ \text{C}$, $V_{ctl} = 0/+3 \text{ Vdc}$ to $+5 \text{ Vdc}$, 50 Ohm System

Parameter	Frequency	Min.	Typ.	Max.	Units
Insertion Loss	DC - 3.0 GHz		0.5	0.8	dB
	DC - 4.5 GHz		0.6	0.9	dB
	DC - 6.0 GHz		0.7	1.0	dB
Isolation (RFC to RF1/RF2)	DC - 4.0 GHz	23	27		dB
	4.0 - 5.0 GHz	26	30		dB
	5.0 - 6.0 GHz	27	32		dB
Return Loss	DC - 3.0 GHz		25		dB
	3.0 - 4.0 GHz		20		dB
	4.0 - 6.0 GHz		12		dB
Input Power for 0.1 dB Compression	(Vctl = 3V)	0.5 - 6.0 GHz	27	29	dBm
	(Vctl = 5V)	0.5 - 6.0 GHz	32	34	dBm
Input Third Order Intercept (Two-Tone Input Power = +7 dBm Each Tone)	(Vctl = 3V, 5V)	0.5 - 1.0 GHz		56	dBm
		1.0 - 3.0 GHz		52	dBm
		3.0 - 6.0 GHz		48	dBm
Switching Speed	tRISE, tFALL (10/90% RF)	DC - 6.0 GHz		15	ns
	tON, tOFF (50% CTL to 10/90% RF)			30	ns

For price, delivery, and to place orders, please contact Hittite Microwave Corporation:
20 Alpha Road, Chelmsford, MA 01824 Phone: 978-250-3343 Fax: 978-250-3373
Order On-line at www.hittite.com



HMC536MS8G / 536MS8GE

GaAs MMIC POSITIVE CONTROL T/R SWITCH, DC - 6 GHz

Insertion Loss

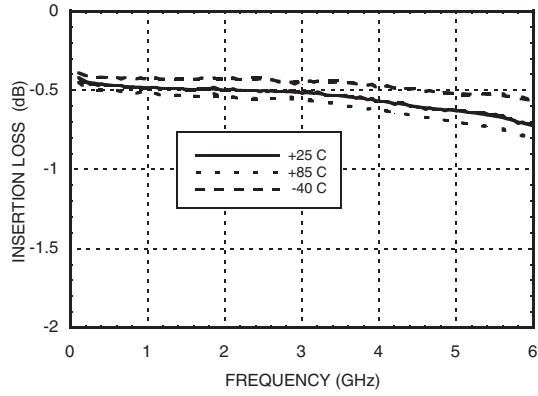

Return Loss

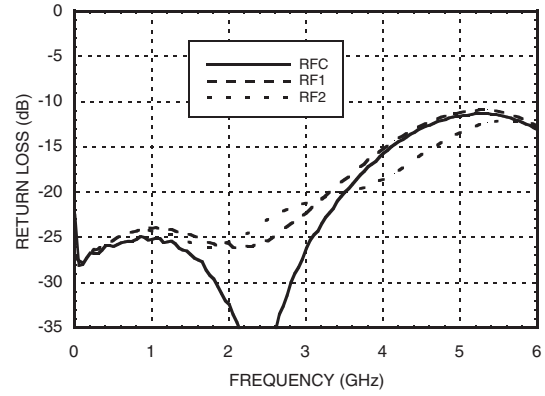

**Isolation Between
Ports RFC and RF1 / RF2**

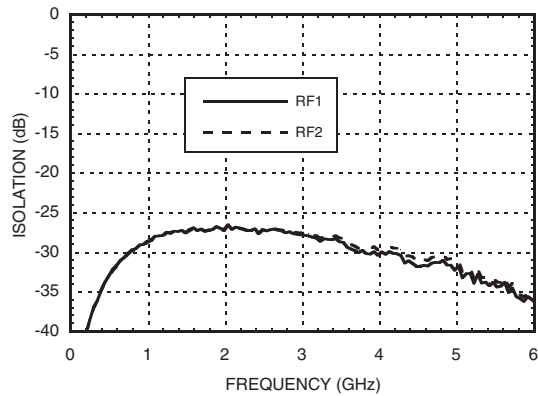

Isolation Between Ports RF1 and RF2

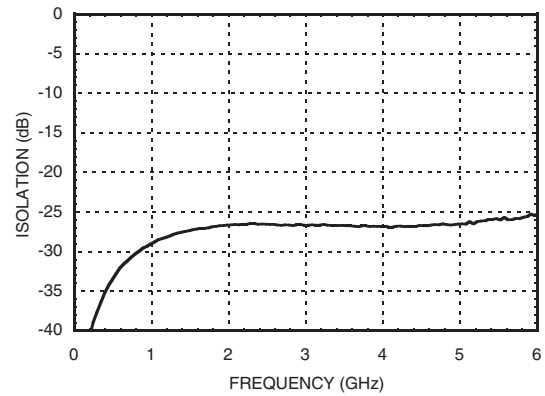

Input 0.1 dB Compression Point

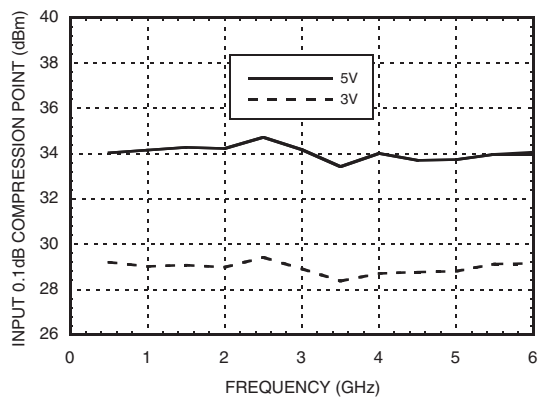

**Input Third Order
Intercept Point, Vctl = 3v**

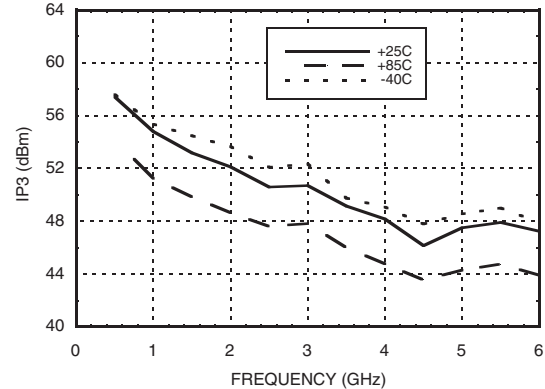

HMC536MS8G / 536MS8GE

GaAs MMIC POSITIVE CONTROL T/R SWITCH, DC - 6 GHz

Absolute Maximum Ratings

Control Voltage Range	-0.5 to +7.5 Vdc
Hot Switch Power Level (Vctl = +3V)	+29 dBm
Channel Temperature	150 °C
Continuous Pdiss (T = 85 °C) (derate 13 mW/°C above 85 °C)	0.867 W
Thermal Resistance	75 °C/W
Storage Temperature	-65 to +150 °C
Operating Temperature	-40 to +85 °C
ESD Sensitivity (HBM)	Class 1A

Control Voltages

*Control Input Tolerances are ± 0.2 Vdc

State	Bias Condition*
Low	0 Vdc @ 25 µA Typical
High	+3 Vdc to +5 Vdc @ 25 µA Typical

Truth Table

Control Input		Signal Path State
A	B	RFC to:
Low	High	RF1
High	Low	RF2

DC blocks are required at ports RFC, RF1, RF2.

Choose value for lowest frequency of operation.

Outline Drawing

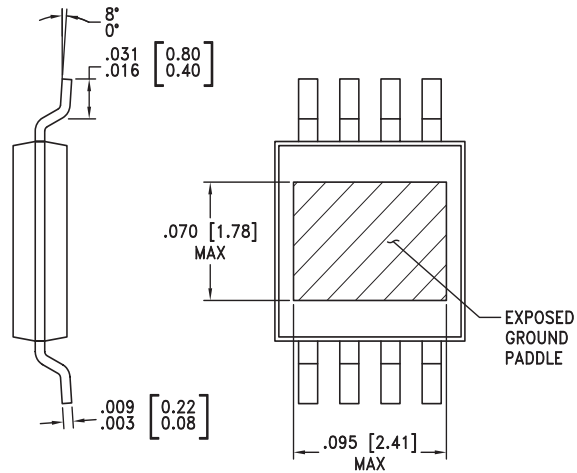
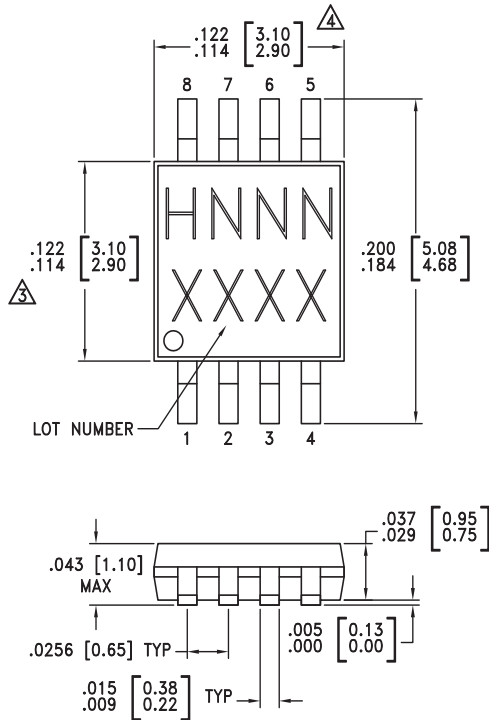

NOTES:

- LEADFRAME MATERIAL: COPPER ALLOY
- DIMENSIONS ARE IN INCHES [MILLIMETERS]
- △ DIMENSION DOES NOT INCLUDE MOLDFLASH OF 0.15mm PER SIDE.
- △ DIMENSION DOES NOT INCLUDE MOLDFLASH OF 0.25mm PER SIDE.
- ALL GROUND LEADS AND GROUND PADDLE MUST BE SOLDERED TO PCB RF GROUND.

Package Information

Part Number	Package Body Material	Lead Finish	MSL Rating	Package Marking ^[3]
HMC536MS8G	Low Stress Injection Molded Plastic	Sn/Pb Solder	MSL1 ^[1]	H536 XXXX
HMC536MS8GE	RoHS-compliant Low Stress Injection Molded Plastic	100% matte Sn	MSL1 ^[2]	H536 XXXX

[1] Max peak reflow temperature of 235 °C



[2] Max peak reflow temperature of 260 °C

[3] 4-Digit lot number XXXX

For price, delivery, and to place orders, please contact Hittite Microwave Corporation:
20 Alpha Road, Chelmsford, MA 01824 Phone: 978-250-3343 Fax: 978-250-3373
Order On-line at www.hittite.com

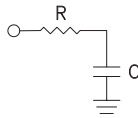

Pin Descriptions

Pin Number	Function	Description	Interface Schematic
1	A	See truth and control voltage tables.	
2	B	See truth and control voltage tables.	
3, 5, 8	RFC, RF1, RF2	These pins are DC coupled and matched to 50 Ohms. Blocking capacitors are required.	
4	N/C	No connection required. This pin may be connected to RF/DC ground without affecting performance	
6, 7	GND	Package bottom has exposed metal paddle that must also be connected to RF/DC ground.	

Evaluation PCB

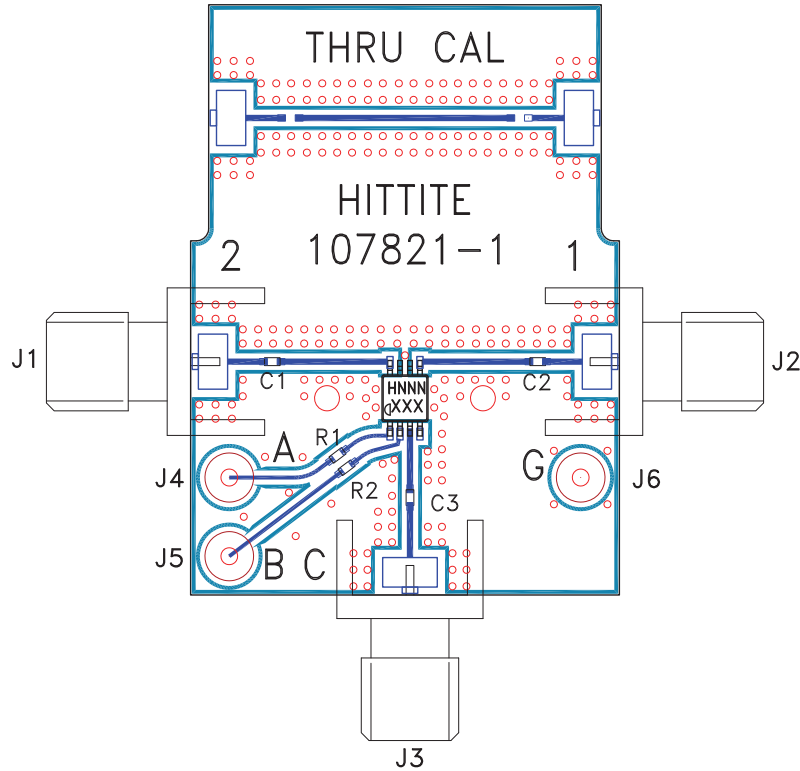

List of Materials for Evaluation PCB 105143 [1]

Item	Description
J1 - J3	PCB Mount SMA RF Connector
J4 - J6	DC Pin
C1 - C3	100 pF Capacitor, 0402 Pkg.
R1 - R2	100 Ohm Resistor, 0402 Pkg.
U1	HMC536MS8G / HMC536MS8GE SPDT Switch
PCB [2]	107821 Evaluation PCB

[1] Reference this number when ordering complete evaluation PCB

[2] Circuit Board Material: Rogers 4350

The circuit board used in the final application should be generated with proper RF circuit design techniques. Signal lines at the RF port should have 50 ohm impedance and the package ground leads and exposed paddle should be connected directly to the ground plane similar to that shown above. The evaluation circuit board shown above is available from Hittite Microwave Corporation upon request.



HMC536MS8G / 536MS8GE

**GaAs MMIC POSITIVE CONTROL
T/R SWITCH, DC - 6 GHz**

Notes:

10

SWITCHES - SMT