

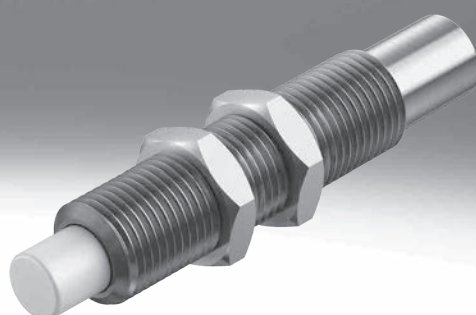

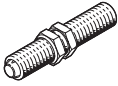

Cushioning components

FESTO

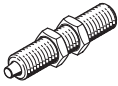
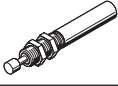
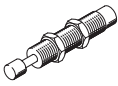

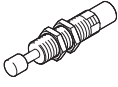

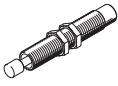
Product range overview

Function	Type	Design	Description	Can be used with
Shock absorber	Elastomer shock absorbers			
	DYEF-Y1		<ul style="list-style-type: none"> Mechanical shock absorber with elastic rubber buffer Cushioning stroke cannot be adjusted No fixed stop Continuous mounting thread with internal hex 	<ul style="list-style-type: none"> Mini slide DGSL
	DYEF-Y1F		<ul style="list-style-type: none"> Mechanical shock absorber with elastic rubber buffer Cushioning stroke can be adjusted With fixed stop Continuous mounting thread with internal hex 	<ul style="list-style-type: none"> Mini slide DGSL Semi-rotary drive DSM-B
	Adjustable			
	DYSR		<ul style="list-style-type: none"> Hydraulic shock absorber with spring return Adjustable cushioning hardness 	–
	Self-adjusting			
	YSR-C		<ul style="list-style-type: none"> Hydraulic shock absorber with path-controlled flow control function Rapidly increasing cushioning force curve Short cushioning stroke Suitable for rotary drives Maintenance-free Continuous mounting thread 	<ul style="list-style-type: none"> Linear drive DGPL Linear drive DGC Linear drive unit SLE
	DYSC		<ul style="list-style-type: none"> Hydraulic shock absorber with path-controlled flow control function Rapidly increasing cushioning force curve Short cushioning stroke Suitable for rotary drives Maintenance-free Metal end position on the housing Continuous mounting thread with internal hex 	<ul style="list-style-type: none"> Semi-rotary drive DSM-B Swivel/linear drive unit DSL-B Semi-rotary drive DRRD
	YSRW		<ul style="list-style-type: none"> Hydraulic shock absorber with path-controlled flow control function Slowly increasing cushioning force curve Long cushioning stroke Suitable for low-vibration operation Short cycle times possible Maintenance-free Continuous mounting thread with spanner flat 	<ul style="list-style-type: none"> Linear drive DGC Handling module HSP, HSW
	DYSS		<ul style="list-style-type: none"> Hydraulic shock absorber with path-controlled flow control function Rapidly increasing cushioning force curve Short cushioning stroke Suitable for low-vibration operation Not suitable for rotary drives Maintenance-free Metal end position on the housing Continuous mounting thread with internal hex 	<ul style="list-style-type: none"> Linear drive DLGF Mini slides DGST
DYSW		<ul style="list-style-type: none"> Hydraulic shock absorber with path-controlled flow control function Slowly increasing cushioning force curve Long cushioning stroke Suitable for low-vibration operation Short cycle times possible Maintenance-free Metal end position on the housing Continuous mounting thread with internal hex 	<ul style="list-style-type: none"> Mini slide DGSL Handling module HSW 	

Product range overview

Size	Stroke [mm]	Energy absorption per stroke [J]	Position sensing	Free of copper and PTFE	→ Page/Internet
Elastomer shock absorbers					
M4, M5, M6, M8, M10, M12, M14, M16	0.9; 1.0; 1.2; 1.3; 1.5	0.015 ... 0.55	–	■	6
M4, M5, M6, M8, M10, M12, M14, M16, M22	1.7; 2.8; 3.1; 3.4; 3.7; 4.2; 5; 4.8; 7	0.005 ... 1.2	–	■	10
Adjustable					
8, 12, 16, 20, 25, 32	8, 12, 20, 25, 40, 60	4 ... 384	–	–	14
Self-adjusting					
4, 5, 7, 8, 10, 12, 16, 20, 25, 32	4, 5, 8, 10, 12, 20, 25, 40, 60	0.6 ... 380	–	■ Size 4 ... 20	18
4, 5, 7, 8, 12, 16, 20, 25	4, 5, 8, 12, 18, 25	0.6 ... 100	–	■	22
5, 7, 8, 10, 12, 16, 20	8, 10, 14, 17, 20, 26, 34	1.3 ... 70	–	■	26
2, 3, 4, 5, 7, 8, 10, 12	4, 5, 8, 10, 12	0.1 ... 10	–	■	30
4, 5, 7, 8, 10, 12	6, 8, 10, 14, 17, 20	0.8 ... 12	–	■	34

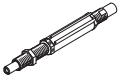
Product range overview

Function	Type	Design	Description	Can be used with
Stop element	Self-adjusting			
	YSRWJ		<ul style="list-style-type: none"> • Cushioning with self-adjusting, progressive hydraulic shock absorbers (YSRW) • Slowly increasing cushioning force curve • Adjustable cushioning stroke • End-position sensing with proximity switch SME/SMT-8 • Precision end-position adjustment • Stop elements YSRWJ can be used for a wide variety of applications in handling and assembly technology. 	–
Hydraulic cushioning cylinder	Adjustable			
	DYHR		<ul style="list-style-type: none"> • Hydraulic cushioning cylinder for constant, slow braking speeds across the entire stroke • Braking speed can be precisely adjusted • A built-in compression spring returns the piston rod to the initial position • Suitable for slow feed speeds in the range up to 0.1 m/s 	–



Product range overview

Size	Stroke [mm]	Energy absorption per stroke [J]	Position sensing	Free of copper and PTFE	→ Page/Internet
Self-adjusting					
5, 7, 8	8, 10, 14	1 ... 3	■	–	38
Adjustable					
16, 20, 25, 32	20, 25, 40, 50, 60	32 ... 384	–	–	42

Type codes

001	Series	
DYEF	Shock absorber	
002	Design type	
	Standard	
S	Short	
003	Size	
M4	M4x0.5	
M5	M5x0.5	
M6	M6x0.5	
M8	M8x1	
M10	M10x1	
M12	M12x1	
M14	M14x1	
M16	M16x1	
004	Geometric characteristics	
Y1	Internal hex	

Data sheet

-  Size
M4 ... M16
-  Stroke length
0.9 ... 1.5 mm



General technical data		M4	M5	M6	M8	M10	M12	M14	M16
Size									
Stroke	[mm]	0.9	1.5	1.5	1.3	1	1.2	1.2	1.3
Mode of operation		Elastomer cushioning without metal fixed stop							
Cushioning		Non-adjustable							
Cushioning length	[mm]	0.9	1.5	1.5	1.3	1	1.2	1.2	1.3
Type of mounting		With lock nut							
Max. impact velocity	[m/s]	0.8							
Mounting position		Any							
Product weight	[g]	2.1	3.6	6	14	23	45.5	82.5	106
	S [g]	1.1	2	3	8.6	12	15	31	40
Ambient temperature	[°C]	0 ... +60							
Corrosion resistance class CRC ¹⁾		2							

1) Corrosion resistance class CRC 2 to Festo standard FN 940070

Moderate corrosion stress. Indoor applications in which condensation can occur. External visible parts with primarily decorative surface requirements which are in direct contact with a normal industrial environment.

Energies [J]		M4	M5	M6	M8	M10	M12	M14	M16
Size									
Max. energy absorption per stroke		0.015	0.05	0.08	0.12	0.25	0.35	0.45	0.55

Mass range [kg]		M4	M5	M6	M8	M10	M12	M14	M16
Size									
Mass range up to		0.15	0.35	0.7	1	2	3	5	7

Data sheet

Materials

Shock absorber

Buffer	Nitrile rubber
Housing	High-alloy steel
Seals	Nitrile rubber
Note on materials	Free of copper and PTFE
	RoHS-compliant

Impact velocity v as a function of mass m

DYEF-(S)-M4/M5-Y1

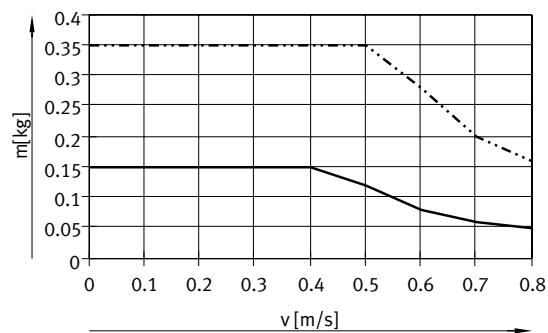

— DYEF-(S)-M4-Y1
 DYEF-(S)-M5-Y1

DYEF-(S)-M6/M8/M10-Y1

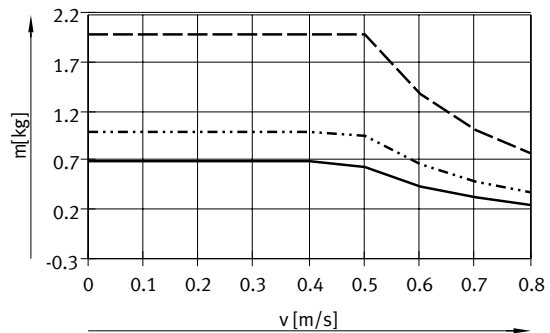

— DYEF-(S)-M6-Y1
 DYEF-(S)-M8-Y1
 - - - - - DYEF-(S)-M10-Y1

DYEF-(S)-M12/M14/M16-Y1

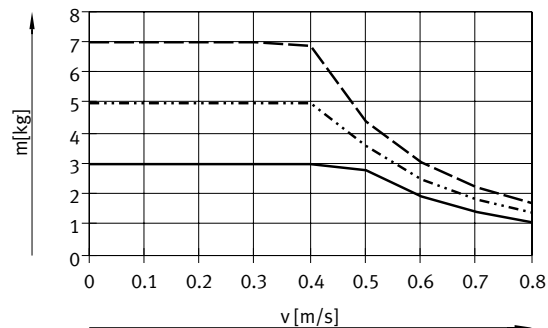

— DYEF-(S)-M12-Y1
 DYEF-(S)-M14-Y1
 - - - - - DYEF-(S)-M16-Y1

Data sheet

Dimensions

Download CAD data → www.festo.com

DYEF-M-... – long design

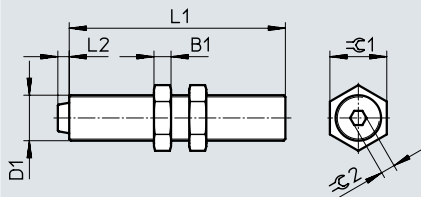

DYEF-S-M-... – short design

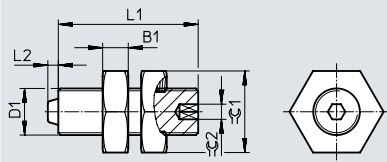

Size	B1	D1	L1		L2 +0.3	$\varnothing 1$	$\varnothing 2$	Max. tightening torque $\varnothing 1$ [Nm]
			DYEF-M	DYEF-S-M				
M4	2.2	M4x0.5	22	12	0.9	7	1.5	0.5
M5	2.7	M5x0.5	26	14.5	1.8	8	1.5	0.8
M6	2.5	M6x0.5	30	15	1.8	8	2	1
M8	3	M8x1	38	23.5	2	10	2.5	2
M10	3.5	M10x1	41	21	1.8	13	3	3
M12	4	M12x1	54	20	2	15	4	5
M14	5	M14x1	72	28	2	17	4	8
M16	5	M16x1	75	31.5	2	19	5	20

Ordering data

Size	Part no.	Type
DYEF-M-... – long design		
M4	1179810	DYEF-M4-Y1
M5	1179818	DYEF-M5-Y1
M6	1179831	DYEF-M6-Y1
M8	1179834	DYEF-M8-Y1
M10	1179837	DYEF-M10-Y1
M12	1179840	DYEF-M12-Y1
M14	1179863	DYEF-M14-Y1
M16	1179879	DYEF-M16-Y1
DYEF-S-M-... – short design		
M4	1152500	DYEF-S-M4-Y1
M5	1152507	DYEF-S-M5-Y1
M6	1152524	DYEF-S-M6-Y1
M8	1152536	DYEF-S-M8-Y1
M10	1152959	DYEF-S-M10-Y1
M12	1153004	DYEF-S-M12-Y1
M14	1153017	DYEF-S-M14-Y1
M16	1153023	DYEF-S-M16-Y1

Type codes



001	Series	
DYEF	Shock absorber	

003	Size	
M4	M4x0.5	
M5	M5x0.5	
M6	M6x0.5	
M8	M8x1	
M10	M10x1	
M12	M12x1	
M14	M14x1	
M16	M16x1	
M22	M22x1.5	

004	Geometric characteristics	
Y1	Internal hex	

005	Stop	
	None	
F	With fixed stop	

Data sheet

-  Size
M4 ... M22
-  Stroke length
1.7 ... 7 mm

**General technical data**

Size	M4	M5	M6	M8	M10	M12	M14	M16	M22
Stroke [mm]	1.7	2.8	3.1	3.4	3.7	4.2	5	4.8	7
Mode of operation	Elastomer cushioning with metallic fixed stop								
Cushioning	Adjustable								
Cushioning length [mm]	1.7	2.8	3.1	3.4	3.7	4.2	5	4.8	7
Type of mounting	With lock nut								
Max. impact velocity [m/s]	0.8								
Mounting position	Any								
Product weight [g]	1.6	2.9	5.1	11.9	19.7	39.6	77.3	104	200
Ambient temperature [°C]	0 ... +60								
Corrosion resistance class CRC ¹⁾	2								

1) Corrosion resistance class CRC 2 to Festo standard FN 940070

Moderate corrosion stress. Indoor applications in which condensation can occur. External visible parts with primarily decorative surface requirements which are in direct contact with a normal industrial environment.

Forces [N]

Size	M4	M5	M6	M8	M10	M12	M14	M16	M22
Min. insertion force ¹⁾	15	30	40	60	70	100	150	180	500

1) This is the minimum force that must be applied so that the shock absorber is pushed precisely into the retracted end position. This value is reduced accordingly in the event of an extended external end position or a reduction in the cushioning stroke.

Energies [J]

Size	M4	M5	M6	M8	M10	M12	M14	M16	M22
Max. energy absorption per stroke	0.005	0.02	0.03	0.04	0.06	0.12	0.2	0.25	1.2

Mass range [kg]

Size	M4	M5	M6	M8	M10	M12	M14	M16	M22
Mass range up to	0.15	0.25	0.4	0.6	1.2	1.8	3	5	15

Data sheet

Materials

Shock absorber	
Buffer	Nitrile rubber
Adjustable sleeve	High-alloy steel
Setting piece	High-alloy steel
Seals	Nitrile rubber
Note on materials	Free of copper and PTFE
	RoHS-compliant

Impact velocity v as a function of mass m

DYEF-M4/M5-Y1F

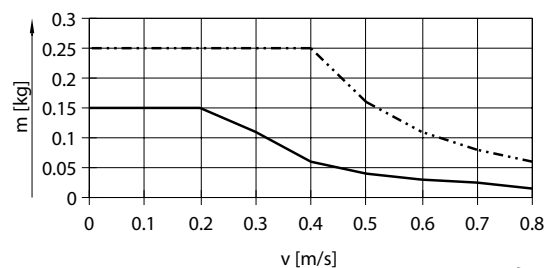

— DYEF-M4-Y1F
 DYEF-M5-Y1F

DYEF-M6/M8/M10-Y1F

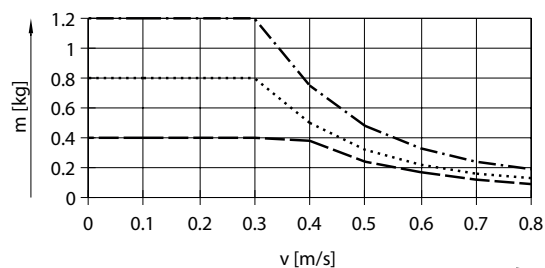

— DYEF-M6-Y1F
 DYEF-M8-Y1F
 - - - - DYEF-M10-Y1F

DYEF-M12/M14/M16-Y1F

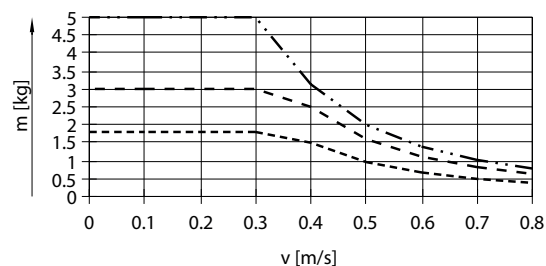

— DYEF-M12-Y1F
 DYEF-M14-Y1F
 - - - - DYEF-M16-Y1F

DYEF-M22-Y1F

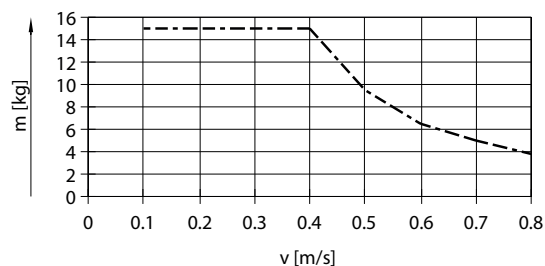

— DYEF-M22-Y1F

Data sheet

Dimensions

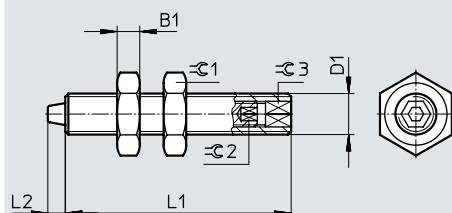
Download CAD data → www.festo.com

Size	B1	D1	L1	L2	$\varnothing 1$	$\varnothing 2$	$\varnothing 3$	Max. tightening torque $\varnothing 1$ [Nm]
M4	2.2	M4x0.5	22	1.7	7	1.3	2.5	0.5
M5	2.7	M5x0.5	26	2.8	8	1.5	3	0.8
M6	2.5	M6x0.5	30	3.1	8	2	4	1
M8	3	M8x1	38	3.4	10	2.5	5	2
M10	3.5	M10x1	41	3.7	13	3	6	3
M12	4	M12x1	54	4.2	15	4	8	5
M14	5	M14x1	72	5	17	4	8	8
M16	5	M16x1	75	4.8	19	5	10	20
M22	5	M22x1.5	78	7	27	5	10	35

Ordering data

Size	Part no.	Type
M4	548370	DYEF-M4-Y1F ¹⁾
M5	548371	DYEF-M5-Y1F
M6	548372	DYEF-M6-Y1F
M8	548373	DYEF-M8-Y1F
M10	548374	DYEF-M10-Y1F
M12	548375	DYEF-M12-Y1F
M14	548376	DYEF-M14-Y1F
M16	548377	DYEF-M16-Y1F
M22	1113706	DYEF-M22-Y1F

1) With this size, the scope of delivery of the drive includes an Allen key.

Peripherals overview and type codes

Peripherals overview

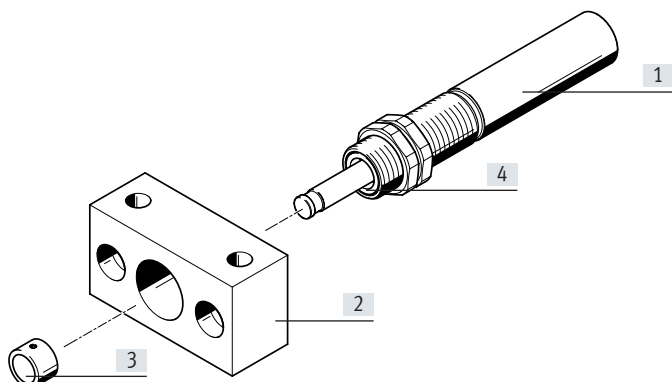

Accessories and special feature

Type	Brief description	→ Page/Internet
[1] Shock absorber DYSR	Hydraulic shock absorber with adjustable cushioning characteristic	14
[2] Mounting flange YSRF	Mounting option for shock absorber	46
[3] Buffer YSRP	For protecting the piston rod	48
[4] Wiper seal ¹⁾ ; hardened piston rod ²⁾	The wiper seal (prevents the ingress of dirt) and the hardened piston rod (protects against scratches) greatly increase the service life	–

1) Size 12 and up

2) Size 16 and up

Type codes

001	Series
DYSR	Shock absorber



002	Size
8	8
12	12
16	16
20	20
25	25
32	32

003	Stroke
8	8
12	12
20	20
25	25
40	40
60	60

004	Geometric characteristics
Y5	Internal hex for adjusting cushioning

005	Product features
	Standard
T	Custom thread

Data sheet

-  - Size
8 ... 32
-  - Stroke length
8 ... 60 mm

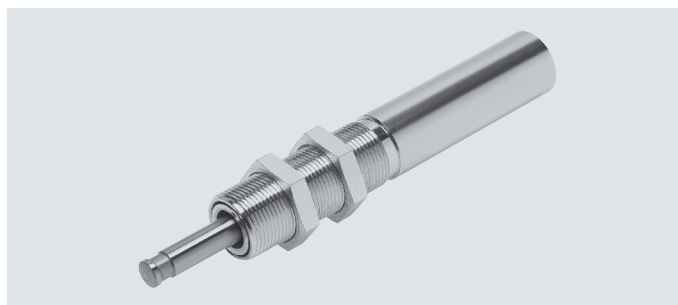

General technical data

Size	8	12	16	20	25	32
Stroke [mm]	8	12	20	25	40	60
Mode of operation	Hydraulic shock absorber with spring return Single-acting, pushing					
Cushioning	Adjustable, force-dependent, hard characteristic curve					
Cushioning length [mm]	8	12	20	25	40	60
Type of mounting	With lock nut					
Impact velocity [m/s]	0.1 ... 3					
Mounting position	Any					
Product weight [g]	60	105/120 ¹⁾	200/250 ¹⁾	355/425 ¹⁾	715	1355
Ambient temperature [°C]	-10 ... +80					
Corrosion resistance class CRC ²⁾	2					

1) Applies to shock absorbers with special thread T

2) Corrosion resistance class CRC 2 to Festo standard FN 940070

Moderate corrosion stress. Indoor applications in which condensation can occur. External visible parts with primarily decorative surface requirements which are in direct contact with a normal industrial environment.

Reset time [s]

Size	8	12	16	20	25	32
Reset time ¹⁾	≤ 0.2		≤ 0.3		≤ 0.4	≤ 0.6

1) The specified technical data refers to room temperature. At -10°C, the reset time can be up to 1 s for sizes 12 and 16, and up to 3 s for sizes 8, 20, 25 and 32.

Forces [N]

Size	8	12	16	20	25	32
Min. insertion force ¹⁾	18	38	66	110	155	175
Max. stop force ²⁾ in the end positions	400	900	1600	2500	4000	6400
Min. resetting force ³⁾	1.8	4.5	5.4	9	12.5	18

1) This is the minimum force that must be applied so that the shock absorber is pushed precisely into the retracted end position. This value is reduced accordingly with an extended external end position.

2) If the maximum stop force is exceeded, a fixed stop (e.g. YSRA) must be fitted 0.5 mm before the end of stroke.

3) This is the maximum force that can act on the piston rod, allowing the shock absorber to fully extend (e.g. extended stud).

Energies [J]

Size	8	12	16	20	25	32
Max. energy absorption per stroke	4	10.8	32	62.5	160	384
Max. energy consumption per hour	24000	60000	100000	135000	220000	330000
Max. residual energy	0.01	0.05	0.16	0.32	0.8	2

Data sheet

Materials

Size	8	12	16	20	25	32
[1] Piston rod	High-alloy steel		Hardened high-alloy steel			
[2] Housing	High-alloy steel	Galvanised steel				
- Buffer	Polyacetal	-				
- Seals	Nitrile rubber					
Note on materials	RoHS-compliant					

Selection graph for shock absorbers with infinitely adjustable cushioning DYSR

Impact velocity v as a function of mass m

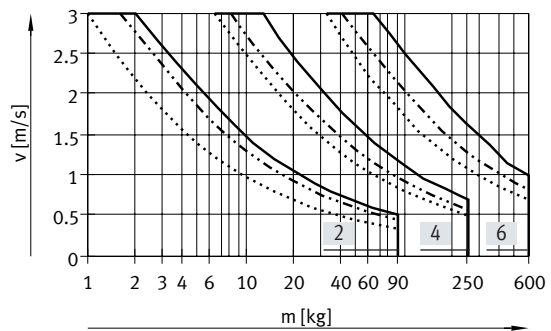
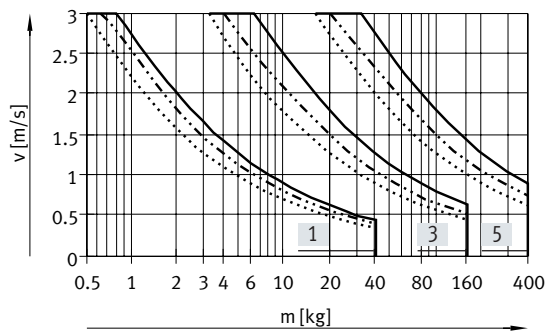

Three force curves are shown for each shock absorber. An average must be taken for intermediate values.

- [1] DYSR-8-8
- [2] DYSR-12-12
- [3] DYSR-16-20
- [4] DYSR-20-25
- [5] DYSR-25-40
- [6] DYSR-32-60

Shock absorber	Force -----	Force -----	Force -----
DYSR-8-8	0 N	100 N	200 N
DYSR-12-12	0 N	200 N	500 N
DYSR-16-20	0 N	500 N	800 N
DYSR-20-25	0 N	800 N	1200 N
DYSR-25-40	0 N	1200 N	2000 N
DYSR-32-60	0 N	2000 N	3000 N

Recommended max. drive force as a function of energy utilisation

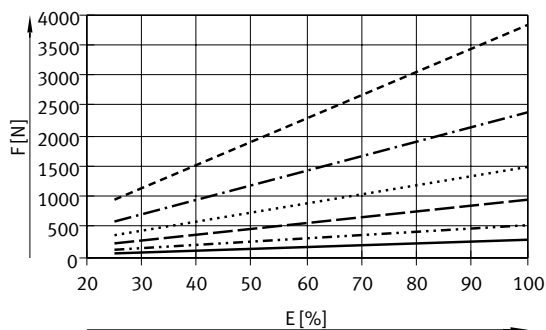

- DYSR-8-8-Y5
- · - · - DYSR-12-12-Y5
- - - - DYSR-16-20-Y5
- · · · · DYSR-20-25-Y5
- · - · - DYSR-25-40-Y5
- - - - DYSR-32-60-Y5

Data sheet

Dimensions

Download CAD data → www.festo.com

DYSR-8-8

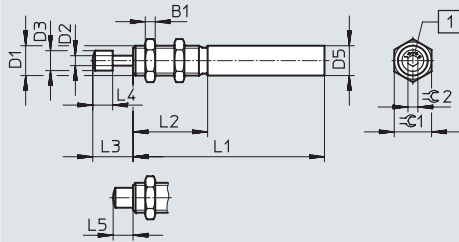

[1] Cushioning adjustment buffer
(included in the scope of delivery)

DYSR-...

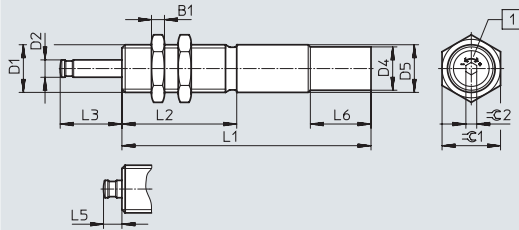

[1] Cushioning adjustment buffer YSRP
(not included in the scope of delivery)

Type	B1	D1	D2 ∅	D3 ∅ ±0.2	D4 ∅ +0.15	D5 ∅ +0.15/-0.1	L1	L2 ±0.1
DYSR-8-8-Y5	4	M12x1	4	8	–	12	77±0.1	30
DYSR-12-12-Y5	5	M15x1	6	–	–	15	97±0.1	36
DYSR-12-12-Y5-T		M16x1				16		
DYSR-16-20-Y5	6	M20x1.25	8	–	–	20	115±0.1	53
DYSR-16-20-Y5-T		M22x1.5			20	22		
DYSR-20-25-Y5	8	M24x1.25	10	–	–	24	138±0.1	60
DYSR-20-25-Y5-T		M26x1.5			24	26		
DYSR-25-40-Y5	10	M30x1.5	12	–	28.8	30	178±0.1	80
DYSR-32-60-Y5	12	M37x1.5	15	–	34.8	37	230±0.15	108

Type	L3	L4 ±0.2	L5	L6 ±0.2	≅C1	≅C2	Max. tightening torque ≅C1 [Nm]
DYSR-8-8-Y5	16.2+0.6/-0.45	8	8+0.5/-0.35	–	15	4	5
DYSR-12-12-Y5	18.4+0.35/-0.2	–	6.4+0.45/-0.4	–	19	5	20
DYSR-12-12-Y5-T							
DYSR-16-20-Y5	28.5+0.4/-0.3	–	8.5+0.45/-0.4	–	24	5	35
DYSR-16-20-Y5-T				28			
DYSR-20-25-Y5	35.6+0.4/-0.3	–	10.6+0.45/-0.4	–	30	5	60
DYSR-20-25-Y5-T				28			
DYSR-25-40-Y5	52.8+0.4/-0.3	–	12.8+0.45/-0.4	28	36	6	80
DYSR-32-60-Y5	76+0.5/-0.4	–	16+0.5/-0.4	28	46	6	100

Ordering data

Size	Part no.	Type
8	1138641	DYSR-8-8-Y5
12	1138642	DYSR-12-12-Y5
	1138643	DYSR-12-12-Y5-T
16	1138644	DYSR-16-20-Y5
	1138645	DYSR-16-20-Y5-T
20	1138646	DYSR-20-25-Y5
	1138647	DYSR-20-25-Y5-T
25	1138648	DYSR-25-40-Y5
32	1138649	DYSR-32-60-Y5

Peripherals overview and type codes

Peripherals overview

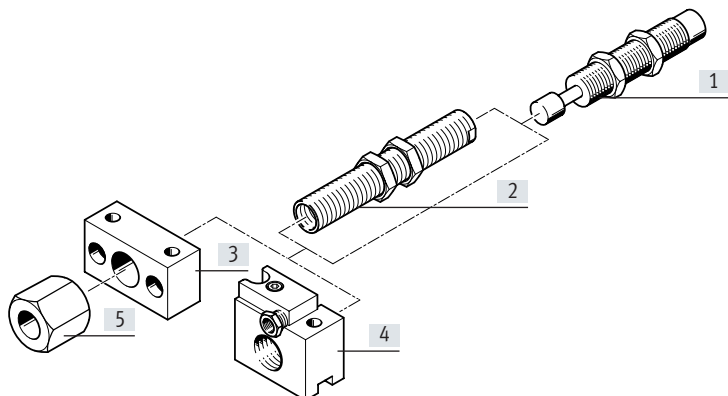

Accessories		
Type	Brief description	→ Page/Internet
[1] Shock absorber YSR-C	Hydraulic shock absorber with rapidly increasing cushioning force curve	18
[2] Reducing sleeve DAYH	To improve cushioning characteristics at low load, the installed shock absorber can be replaced with the next size down shock absorber using the reducing sleeve.	49
[3] Mounting flange YSRF	Mounting option for shock absorber	46
[4] Mounting flange YSRF-S	Mounting option for shock absorber with integrated, attached stop sleeve and position sensing	47
[5] End stop limiter YSRA	Stroke limiter for shock absorber	48
– Inductive proximity switches SIEN	For mounting flange YSRF-S	50

Type codes



001	Series
YSR	Shock absorber

002	Size
4	4
5	5
7	7
8	8
10	10
12	12
16	16
20	20
25	25
32	32

003	Stroke
4	4
5	5
8	8
10	10
12	12
20	20
25	25
40	40
60	60

004	Cushioning
C	Self-regulating

Data sheet

-  - Size
 4 ... 32
-  - Stroke length
 4 ... 60 mm

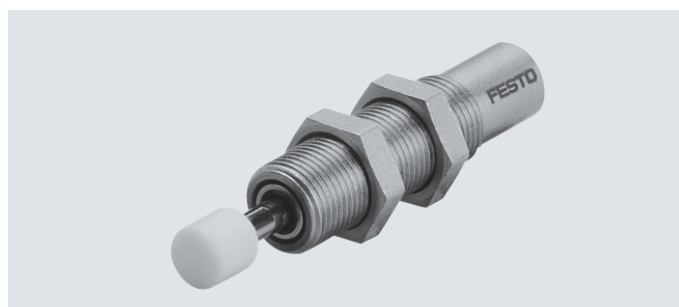

General technical data										
Size	4	5	7	8	10	12	16	20	25	32
Stroke [mm]	4	5	5	8	10	12	20	25	40	60
Mode of operation	Hydraulic shock absorber with spring return									
	Single-acting, pushing									
Cushioning	Self-adjusting, hard characteristic curve									
Cushioning length [mm]	4	5	5	8	10	12	20	25	40	60
Type of mounting	With lock nut									
Impact velocity [m/s]	0.05 ... 2		0.05 ... 3							
Mounting position	Any									
Product weight [g]	5	8	16	32	51	74	185	318	600	1220
Ambient temperature [°C]	-10 ... +80									
Corrosion resistance class CRC ¹⁾	2									

1) Corrosion resistance class CRC 2 to Festo standard FN 940070

Moderate corrosion stress. Indoor applications in which condensation can occur. External visible parts with primarily decorative surface requirements which are in direct contact with a normal industrial environment.

Reset time [s]										
Size	4	5	7	8	10	12	16	20	25	32
Reset time ¹⁾	≤ 0.2					≤ 0.3			≤ 0.4	≤ 0.5

1) The specified technical data refers to room temperature. At higher temperatures in the region of 80°C, the maximum mass and the cushioning energy must be reduced by approximately 50%. At -10°C, the reset time may be up to 1 second.

Forces [N]										
Size	4	5	7	8	10	12	16	20	25	32
Min. insertion force ¹⁾	6.5	7.5	10	18	25	35	60	100	140	160
Max. stop force ²⁾ in the end positions	100	200	300	500	700	1000	2000	3000	4000	6000
Min. resetting force ³⁾	0.7	0.9	1.2	2.5	3.5	5	6	10	14	20

1) This is the minimum force that must be applied so that the shock absorber is pushed precisely into the retracted end position. This value is reduced accordingly with an extended external end position.

2) If the maximum stop force is exceeded, a fixed stop (e.g. YSRA) must be fitted 0.5 mm before the end of stroke.

3) This is the maximum force that can act on the piston rod, allowing the shock absorber to fully extend (e.g. extended stud).

Energies [J]										
Size	4	5	7	8	10	12	16	20	25	32
Max. energy absorption per stroke	0.6	1	2	3	6	10	30	60	160	380
Max. energy consumption per hour	5600	8000	12000	18000	26000	36000	64000	92000	150000	220000
Max. residual energy	0.006	0.01		0.02	0.03	0.05	0.16	0.32	0.8	2

Mass range [kg]										
Size	4	5	7	8	10	12	16	20	25	32
Mass range up to	1.2	1.5	5	15	25	45	90	120	200	400

Data sheet

Materials

Size	4	5	7	8	10	12	16	20	25	32
[1] Housing	High-alloy steel				Galvanised steel					
[2] Piston rod	High-alloy steel									
[3] Buffer	Polyamide								Steel with polyurethane	
- Seals	Nitrile rubber, polyurethane									
- Note on materials	Free of copper and PTFE								-	
	RoHS-compliant									

Selection graph for self-adjusting shock absorbers YSR-C

Impact velocity v as a function of mass m

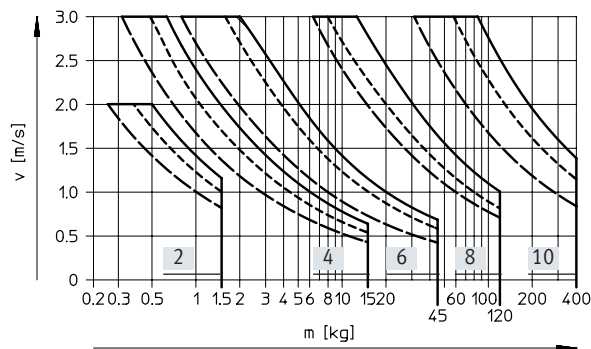
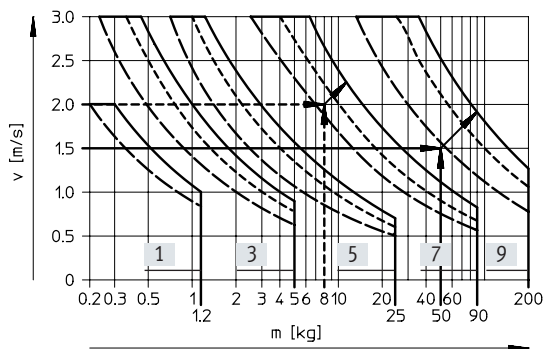

Three force curves are shown for each shock absorber. An average must be taken for intermediate values.

- [1] YSR-4-4-C
- [2] YSR-5-5-C
- [3] YSR-7-5-C
- [4] YSR-8-8-C
- [5] YSR-10-10-C
- [6] YSR-12-12-C
- [7] YSR-16-20-C
- [8] YSR-20-25-C
- [9] YSR-25-40-C
- [10] YSR-32-60-C

Shock absorber	Force -----	Force	Force -----
YSR-4-4-C	0 N	-	50 N
YSR-5-5-C	0 N	50 N	100 N
YSR-7-5-C	0 N	100 N	200 N
YSR-8-8-C	0 N	100 N	200 N
YSR-10-10-C	0 N	150 N	300 N
YSR-12-12-C	0 N	200 N	500 N
YSR-16-20-C	0 N	500 N	800 N
YSR-20-25-C	0 N	800 N	1200 N
YSR-25-40-C	0 N	1200 N	2500 N
YSR-32-60-C	0 N	2000 N	4000 N

Data sheet

Dimensions

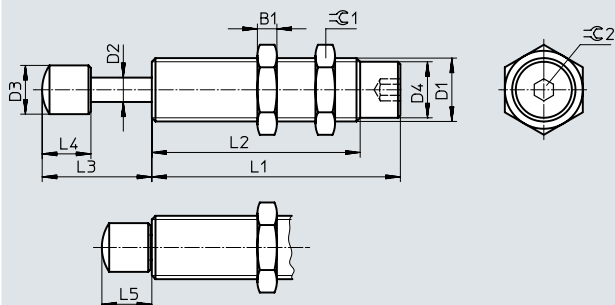
Download CAD data → www.festo.com**Note**

To increase the service life:
Prevent dirt or liquids getting into the inner chamber of the piston via the piston rod (e.g. by using a cover).

Size	B1	D1	D2 ∅	D3 ∅	D4 ∅	L1 ±0.1
4	2.5	M6x0.5	2	3.5 ±0.05	5.3 ±0.05	28.5
5	3	M8x1	2.5	4.7 ±0.05	6.7 ±0.05	29
7	3.5	M10x1	3	6 ±0.1	8.6 ±0.05	34
8	4	M12x1	4	8 ±0.2	10.4 ±0.1	46
10	5	M14x1	5	10 ±0.2	12.4 ±0.1	55
12	5	M16x1	6	12 ±0.2	14.5 ±0.1	64
16	6	M22x1.5	8	16 ±0.2	19.6 ±0.1	86
20	8	M26x1.5	10	20 ±0.2	23.8 ±0.1	104
25	10	M30x1.5	12	25 ±0.2	27.8 ±0.1	152
32	12	M37x1.5	15	32 ±0.2	34.8 ±0.1	205

Size	L2 ±0.3	L3	L4	L5	⊖C1	⊖C2	Max. tightening torque ⊖C1 [Nm]
4	18.5	8.3 +0.6/-0.3	4 ±0.1	4.3 +0.35/-0.25	8	2	1
5	19	10.8 +0.6/-0.3	5.5 ±0.1	5.8 +0.55/-0.25	10	-	2
7	23	12.3 +0.7/-0.35	7 ±0.2	7.3 +0.55/-0.25	13		3
8	33	16.3 +0.7/-0.35	8 ±0.2	8.3 +0.55/-0.25	15		5
10	42	20.5 +0.7/-0.35	10 ±0.2	10.5 +0.55/-0.25	17		8
12	51	24.5 +0.7/-0.35	12 ±0.2	12.5 +0.55/-0.25	19		20
16	69	36.5 +0.7/-0.35	16 ±0.2	16.5 +0.55/-0.25	27		35
20	87	45.5 +0.7/-0.35	20 ±0.2	20.5 +0.55/-0.25	32		60
25	125	61.5 +1.25/-0.75	20.5 ±0.4	21.5 +0.95/-0.55	36		80
32	179	87 +1.25/-0.75	26 ±0.4	27 +0.95/-0.55	46		100

Ordering data

Size	Part no.	Type
4	540060	YSR-4-4-C ¹⁾
5	158981	YSR-5-5-C ¹⁾
7	160272	YSR-7-5-C ¹⁾
8	34571	YSR-8-8-C ¹⁾
10	191199	YSR-10-10-C ¹⁾
12	34572	YSR-12-12-C ¹⁾
16	34573	YSR-16-20-C ¹⁾
20	34574	YSR-20-25-C ¹⁾
25	160273	YSR-25-40-C
32	160274	YSR-32-60-C

1) Free of copper and PTFE

Peripherals overview and type codes

Peripherals overview

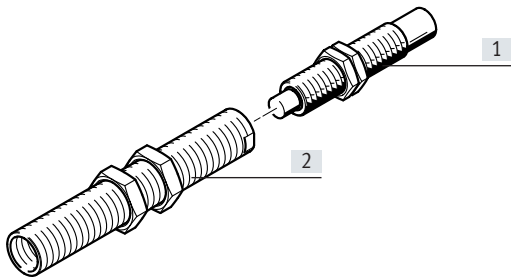

Accessories		
Type	Brief description	→ Page/Internet
[1] Shock absorber DYSC	Hydraulic shock absorber with rapidly increasing cushioning force curve	22
[2] Reducing sleeve DAYH	To improve cushioning characteristics at low load, the installed shock absorber can be replaced with the next size down shock absorber using the reducing sleeve.	49

Type codes

001	Series
DYSC	Shock absorber



002	Size
4	4
5	5
7	7
8	8
12	12
16	16
20	20
25	25

003	Stroke
4	4
5	5
8	8
12	12
18	18
25	25

004	Geometric characteristics
Y1	Internal hex

005	Stop
F	With fixed stop

Data sheet

-  - Size
 4 ... 25
-  - Stroke length
 4 ... 25 mm

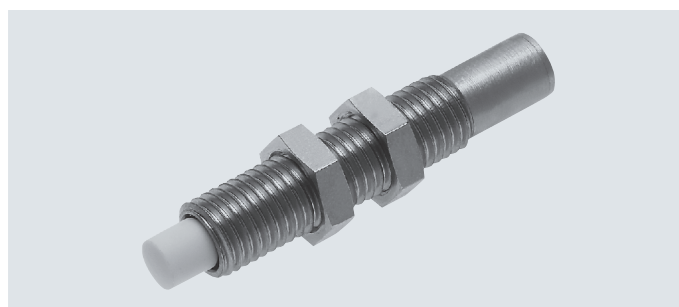

General technical data										
Size		4	5	7	8	12	16	20	25	
Stroke	[mm]	4	5	5	8	12	18	18	25	
Mode of operation		Hydraulic shock absorber with spring return								
		Single-acting, pushing								
Cushioning		Self-adjusting, hard characteristic curve								
Cushioning length	[mm]	4	5	5	8	12	18	16	25	
Type of mounting		With lock nut								
Impact velocity	[m/s]	0.05 ... 2			0.05 ... 3					
Mounting position		Any								
Product weight	[g]	5	9	17	36	81	210	370	575	
Ambient temperature	[°C]	-10 ... +80								
Corrosion resistance class CRC ¹⁾		2								

1) Corrosion resistance class 2 to Festo standard 940 070

Components subject to moderate corrosion stress. External visible parts with primarily decorative surface requirements which are in direct contact with a normal industrial environment or media such as coolants or lubricating agents.

Reset time [s]										
Size		4	5	7	8	12	16	20	25	
Reset time ¹⁾		≤ 0.2					≤ 0.3			

1) The specified technical data refers to room temperature. At higher temperatures in the region of 80°C, the maximum mass and the cushioning energy must be reduced by approximately 50%. At -10°C, the reset time may be up to 1 second.

Forces [N]									
Size		4	5	7	8	12	16	20	25
Min. insertion force ¹⁾		6.5	7.5	10	18	35	60	100	140
Max. stop force ²⁾ in the end positions		100	200	300	500	1000	2000	3000	4000
Min. resetting force ³⁾		0.7	0.9	1.2	2.5	5	6	10	14

1) This is the minimum force that must be applied so that the shock absorber is pushed precisely into the retracted end position. This value is reduced accordingly with an extended external end position.

2) If the maximum stop force is exceeded, a fixed stop (e.g. YSRA) must be fitted 0.5 mm before the end of stroke.

3) This is the maximum force that can act on the piston rod, allowing the shock absorber to fully extend (e.g. extended stud).

Energies [J]									
Size		4	5	7	8	12	16	20	25
Max. energy absorption per stroke		0.6	1	2	3	10	25	38	100
Max. energy consumption per hour		5600	8000	12000	18000	36000	50000	80000	140000
Max. residual energy		0.006	0.01		0.02	0.05	0.16	0.32	0.8

Mass range [kg]									
Size		4	5	7	8	12	16	20	25
Mass range up to		1.2	1.5	5	15	45	70	100	160

Data sheet

Materials

Size	4	5	7	8	12	16	20	25
[1] Buffer	POM							
[2] Piston rod	High-alloy steel							
[3] Housing	High-alloy steel				Galvanised steel			
- Seals	NBR							
Note on materials	Free of copper and PTFE							
	RoHS-compliant							

Selection graph for self-adjusting shock absorbers DYSC

Impact velocity v as a function of mass m

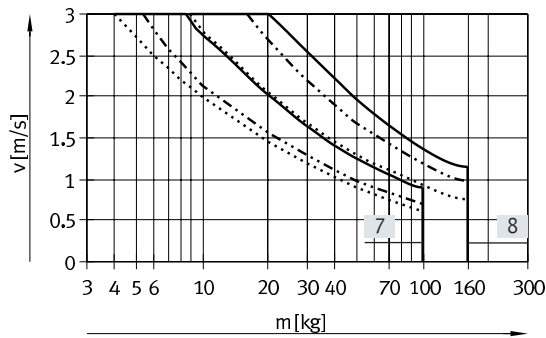
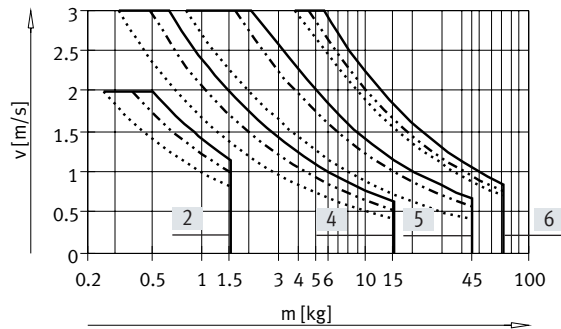
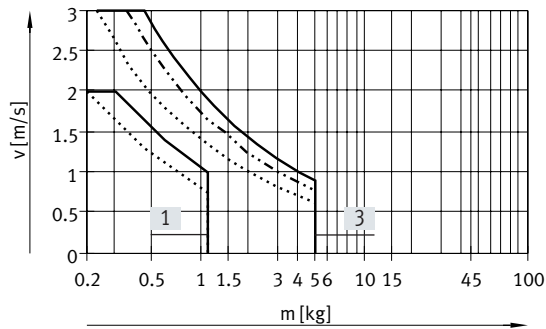

Three force curves are shown for each shock absorber. An average must be taken for intermediate values.

- [1] DYSC-4-4-Y1F
- [2] DYSC-5-5-Y1F
- [3] DYSC-7-5-Y1F

- [4] DYSC-8-8-Y1F
- [5] DYSC-12-12-Y1F
- [6] DYSC-16-18-Y1F

- [7] DYSC-20-18-Y1F
- [8] DYSC-25-25-Y1F

Shock absorber	Force -----	Force - - - - -	Force
DYSC-4-4-Y1F	0 N	-	50 N
DYSC-5-5-Y1F	0 N	50 N	100 N
DYSC-7-5-Y1F	0 N	100 N	200 N
DYSC-8-8-Y1F	0 N	100 N	200 N
DYSC-12-12-Y1F	0 N	200 N	500 N
DYSC-16-18-Y1F	0 N	500 N	800 N
DYSC-20-18-Y1F	0 N	800 N	1200 N
DYSC-25-25-Y1F	0 N	1200 N	2500 N

Data sheet

Dimensions

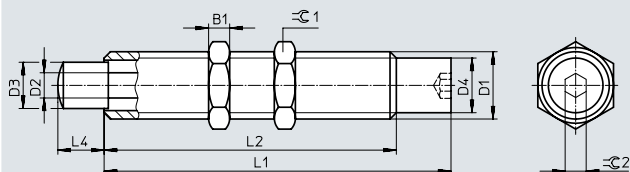
Download CAD data → www.festo.com

Shock absorber in end position

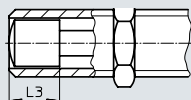
**Note**

To increase the service life:
Prevent dirt or liquids getting into the inner chamber of the piston via the piston rod (e.g. by using a cover).

Size	B1	D1	D2 ∅	D3 ∅	D4 ∅	L1 +0.1	L2 +0.3/-0.2
4	2.5	M6x0.5	2	3.5 ±0.05	5.35 ±0.05	35.5	25.5
5	3	M8x1	2.5	4.7 ±0.05	6.7 ±0.05	38.6	28.6
7	3.5	M10x1	3	6 ±0.1	8.6 ±0.05	45.15	34.15
8	4	M12x1	4	7 ±0.1	10.4 ±0.1	59.05	46.05
12	5	M16x1	6	11 ±0.1	14.5 ±0.1	82.5	69.5
16	6	M22x1.5	8	15 ±0.1	19.6 ±0.1	110	93
20	8	M26x1.5	10	18.8 ±0.1	23.8 ±0.1	122	105
25	10	M30x1.5	12	22.8 ±0.1	27.8 ±0.1	165	137

Size	L3 ¹⁾	L4	∅C1	∅C2	Max. tightening torque ∅C1 [Nm]
4	4	4 +0.30/-0.24	8	2	1
5	5.5	5 +0.32/-0.28	10	2.5	2
7	7	5 +0.37/-0.28	13	3	3
8	8	8 +0.42/-0.33	15	4	5
12	12	12 +0.50/-0.35	19	5	20
16	18	18 +0.50/-0.35	27	5	35
20	20	18 +0.50/-0.35	32	6	60
25	22	25 +0.50/-0.35	36	8	80

1) Buffer length

Ordering data

Size	Part no.	Type
4	570506	DYSC-4-4-Y1F
5	548011	DYSC-5-5-Y1F
7	548012	DYSC-7-5-Y1F
8	548013	DYSC-8-8-Y1F
12	548014	DYSC-12-12-Y1F
16	553593	DYSC-16-18-Y1F
20	2479149	DYSC-20-18-Y1F
25	2480234	DYSC-25-25-Y1F

Peripherals overview and type codes

Peripherals overview

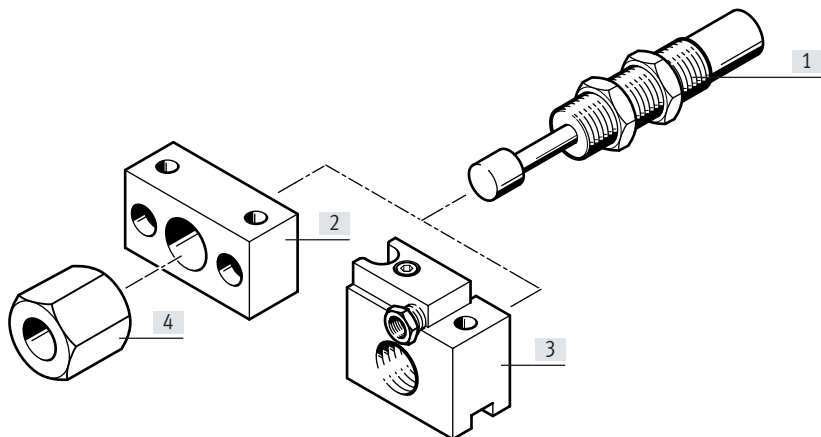

Accessories		
Type	Brief description	→ Page/Internet
[1] Shock absorber YSRW	Hydraulic shock absorber with progressive cushioning characteristic	26
[2] Mounting flange YSRF	Mounting option for shock absorber	46
[3] Mounting flange YSRF-S	Mounting option for shock absorber with integrated, attached stop sleeve and position sensing	47
[4] End stop limiter YSRA	Stroke limiter for shock absorber	48
– Inductive proximity switches SIEN	For mounting flange YSRF-S	50



Type codes

001	Series
YSRW	Shock absorber

002	Size
5	5
7	7
8	8
10	10
12	12
16	16
20	20

003	Stroke
8	8
10	10
14	14
17	17
20	20
26	26
34	34

Data sheet

-  - Size
5 ... 20
-  - Stroke length
8 ... 34 mm

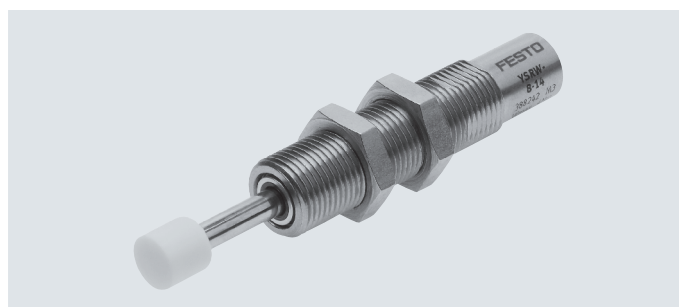

General technical data								
Size		5	7	8	10	12	16	20
Stroke	[mm]	8	10	14	17	20	26	34
Mode of operation		Hydraulic shock absorber with spring return						
		Single-acting, pushing						
Cushioning		Self-adjusting, soft characteristic curve						
Cushioning length	[mm]	8	10	14	17	20	26	34
Type of mounting		With lock nut						
Impact velocity	[m/s]	0.1 ... 2	0.1 ... 3					
Mounting position		Any						
Product weight	[g]	8	18	34	54	78	190	330
Ambient temperature	[°C]	-10 ... +80						
Corrosion resistance class CRC ¹⁾		2						

1) Corrosion resistance class CRC 2 to Festo standard FN 940070

Moderate corrosion stress. Indoor applications in which condensation can occur. External visible parts with primarily decorative surface requirements which are in direct contact with a normal industrial environment.

Reset time [s]								
Size		5	7	8	10	12	16	20
Reset time ¹⁾		≤ 0.2				≤ 0.3		

1) The specified technical data refers to room temperature. At higher temperatures in the region of 80°C, the maximum mass and the cushioning energy must be reduced by approximately 50%. At -10°C, the reset time may be up to 1 second.

Forces [N]								
Size		5	7	8	10	12	16	20
Min. insertion force ¹⁾		7.5	10	18	25	35	60	100
Max. stop force ²⁾ in the end positions		200	300	500	700	1000	2000	3000
Min. resetting force ³⁾		0.9	1.2	2.5	3.5	5	6	10

1) This is the minimum force that must be applied so that the shock absorber is pushed precisely into the retracted end position. This value is reduced accordingly with an extended external end position.

2) If the maximum stop force is exceeded, a fixed stop (e.g. YSRA) must be fitted 0.5 mm before the end of stroke.

3) This is the maximum force that can act on the piston rod, allowing the shock absorber to fully extend (e.g. extended stud).

Energies [J]								
Size		5	7	8	10	12	16	20
Max. energy absorption per stroke		1.3	2.5	4	8	12	35	70
Max. energy consumption per hour		10000	15000	21000	30000	41000	68000	100000
Max. residual energy		0.01		0.02	0.03	0.05	0.16	0.32

Mass range [kg]								
Size		5	7	8	10	12	16	20
Mass range up to		2	5	10	20	30	50	80

Data sheet

Materials

Size	5	7	8	10	12	16	20
[1] Buffer	Polyamide						
[2] Piston rod	High-alloy steel						
[3] Housing	High-alloy steel			Galvanised steel			
- Seals	Nitrile rubber						
Note on materials	Free of copper and PTFE						
	RoHS-compliant						

Selection graph for self-adjusting shock absorbers with progressive characteristics YSRW

Impact velocity v as a function of mass m

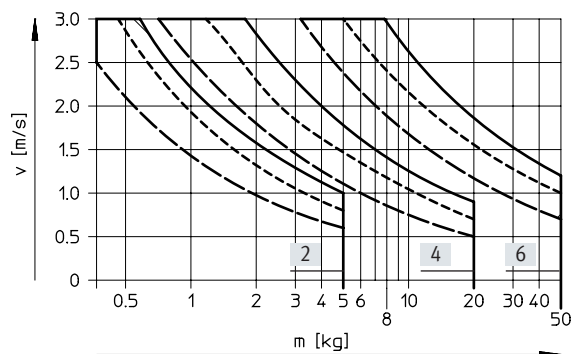
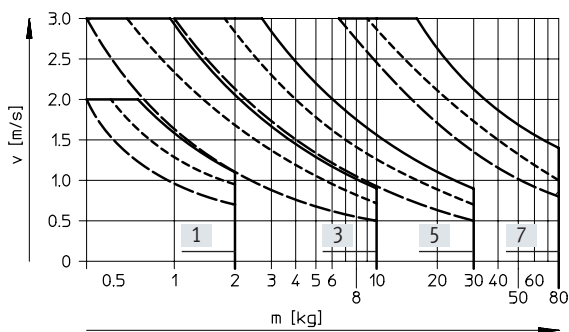

Three force curves are shown for each shock absorber. An average must be taken for intermediate values.

- [1] YSRW-5-8
- [2] YSRW-7-10
- [3] YSRW-8-14
- [4] YSRW-10-17

- [5] YSRW-12-20
- [6] YSRW-16-26
- [7] YSRW-20-34

Shock absorber	Force -----	Force	Force -----
YSRW-5-8	0 N	50 N	100 N
YSRW-7-10	0 N	75 N	150 N
YSRW-8-14	0 N	100 N	200 N
YSRW-10-17	0 N	150 N	300 N
YSRW-12-20	0 N	200 N	400 N
YSRW-16-26	0 N	500 N	800 N
YSRW-20-34	0 N	800 N	1200 N

Data sheet

Dimensions

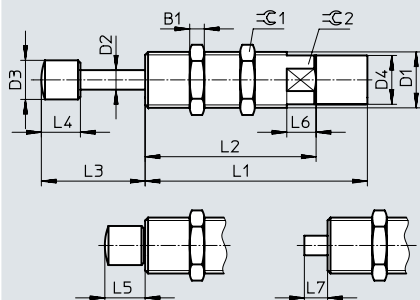
Download CAD data → www.festo.com

 - **Note**

To increase the service life:
Prevent dirt or liquids getting into
the inner chamber of the piston on
the piston rod (e.g. by using a
cover).

Size	B1	D1	D2 ∅	D3 ∅	D4 ∅	L1 ±0.1	L2 ±0.3	L3
5	3	M8x1	2.5	4.7 ±0.05	6.7 ±0.05	33.5	22.5	13.8 +0.6/-0.25
7	3.5	M10x1	3	6 ±0.1	8.6 ±0.05	41	30	17.3 +0.7/-0.25
8	4	M12x1	4	8 ±0.2	10.4 ±0.1	53	40	22.3 +0.7/-0.25
10	5	M14x1	5	10 ±0.2	12.4 ±0.1	62	49	27.5 +0.7/-0.25
12	5	M16x1	6	12 ±0.2	14.5 ±0.1	72.5	59.5	32.5 +0.7/-0.25
16	6	M22x1.5	8	16 ±0.2	20 ±0.1	91	70	42.5 +0.7/-0.35
20	8	M26x1.5	10	18.8 ±0.2	24 ±0.1	112	91	54.5 +0.7/-0.35

Size	L4	L5	L6 +0.5	L7	∅C1	∅C2	Max. tightening torque ∅C1 [Nm]
5	5.5 ±0.1	5.8 +0.35/-0.25	5	3.5 ±0.25	10	7	2
7	7 ±0.2	7.3 +0.35/-0.25	6	4.3 ±0.25	13	9	3
8	8 ±0.2	8.3 +0.4/-0.25	8	5.3 +0.3/-0.25	15	11	5
10	10 ±0.2	10.5 +0.4/-0.25	10	6.5 +0.3/-0.25	17	13	8
12	12 ±0.2	12.5 +0.4/-0.25	12	7.5 +0.3/-0.25	19	15	20
16	16 ±0.2	16.5 +0.4/-0.25	12	9.5 +0.3/-0.25	27	20	35
20	20 ±0.2	20.5 +0.4/-0.25	12	11.5 +0.3/-0.25	32	24	60

Ordering data

Size	Part no.	Type
5	191192	YSRW-5-8
7	191193	YSRW-7-10
8	191194	YSRW-8-14
10	191195	YSRW-10-17
12	191196	YSRW-12-20
16	191197	YSRW-16-26
20	191198	YSRW-20-34

Type codes

001	Series
DYSS	Shock absorber

002	Size
2	2
3	3
4	4
5	5
7	7
8	8
10	10
12	12

003	Stroke
4	4
5	5
8	8
10	10
12	12



004	Geometric characteristics
Y1	Internal hex

005	Stop
F	With fixed stop

 **Note**

The following technical data also apply to the shock absorber DYSS-G8-...

Data sheet

-  - Size
2 ... 12
-  - Stroke length
4 ... 12 mm



General technical data									
Size		2	3	4	5	7	8	10	12
Stroke	[mm]	4	4	4	5	5	8	10	12
Mode of operation		Hydraulic shock absorber with spring return Single-acting, pushing							
Cushioning		Self-adjusting, soft characteristic curve							
Cushioning length	[mm]	4	4	4	5	5	8	10	12
Type of mounting		With lock nut							
Impact velocity	[m/s]	0.1 ... 0.5	0.1 ... 1			0.1 ... 1.5			
Mounting position		Any							
Product weight ¹⁾	[g]	1	3	4.5	7	15	30	51	82
Ambient temperature	[°C]	-10 ... +70		-10 ... +80				-5 ... +80	
Corrosion resistance class CRC ²⁾		2							

1) Weight without nut.

2) Corrosion resistance class CRC 2 to Festo standard FN 940070

Moderate corrosion stress. Indoor applications in which condensation can occur. External visible parts with primarily decorative surface requirements which are in direct contact with a normal industrial environment.

Reset time [s]									
Size		2	3	4	5	7	8	10	12
Reset time ¹⁾		≤ 0.5	≤ 0.2						

1) The specified technical data refers to room temperature. At higher temperatures in the region of 80°C, the maximum mass and the cushioning energy must be reduced by approximately 50%. At -10°C, the reset time may be up to 1 second.

Increased reset times must be expected with longer dwell time in the end position.

Forces [N]									
Size		2	3	4	5	7	8	10	12
Min. insertion force ¹⁾		2.5	3.5	4.5	10	10	18	24	35
Max. stop force ²⁾ in end positions (housing)		60	80	100	200	300	500	700	1000
Min. resetting force ³⁾		0.8	0.5	0.8	0.9	1.2	2.5	4	4

1) This is the minimum force that must be applied so that the shock absorber is pushed precisely into the retracted end position. This value is reduced accordingly with an extended external end position.

2) If the maximum stop force is exceeded, a fixed stop (e.g. YSRA) must be fitted 0.5 mm before the end of stroke.

3) This is the maximum force that can act on the piston rod, allowing the shock absorber to fully extend (e.g. extended stud).

Energies									
Size		2	3	4	5	7	8	10	12
Max. energy absorption per stroke at +20°C	[J]	0.1	0.4	0.8	1.4	2	3	6	10
Max. energy absorption per hour at +20°C	[kJ]	0.27	4.5	5.5	8	12	18	25	36
Max. operating frequency ¹⁾	[Cycles/min]	50	80	80	80	70	50	50	50
Max. residual energy		0.003	0.004	0.006	0.01	0.01	0.02	0.03	0.05

1) For energy utilisation of 70% or above per stroke.

Data sheet

Mass range [kg]	2	3	4	5	7	8	10	12
Size								
Mass range up to	0.8	1	1.7	2.5	5.5	15	20	45

Materials

Shock absorber	
Buffer	POM
Piston rod	High-alloy steel
Housing	High-alloy steel
Seals	NBR
Note on materials	RoHS-compliant

Selection graph for self-adjusting shock absorbers with progressive characteristics DYSS
Impact velocity v as a function of mass m

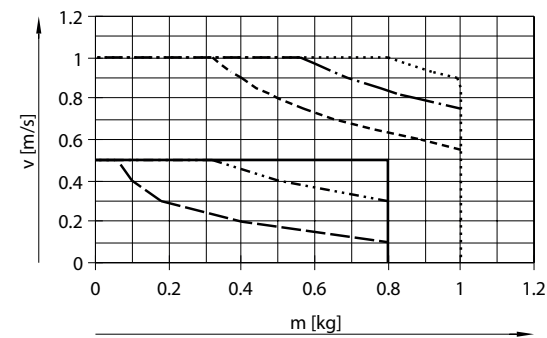

- DYSS-2-4 (0 N)
- ⋯ DYSS-2-4 (15 N)
- - - DYSS-2-4 (23 N)
- ⋯ DYSS-3-4 (0 N)
- - - DYSS-3-4 (30 N)
- - - DYSS-3-4 (60 N)

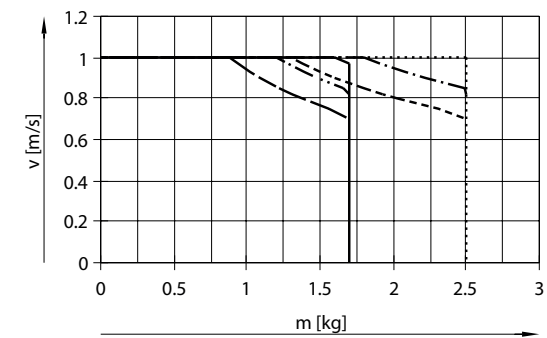

- DYSS-4-4 (0 N)
- ⋯ DYSS-4-4 (50 N)
- - - DYSS-4-4 (90 N)
- ⋯ DYSS-5-5 (0 N)
- - - DYSS-5-5 (100 N)
- - - DYSS-5-5 (150 N)

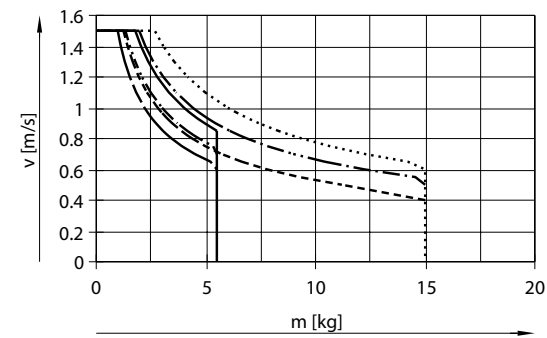

- DYSS-7-5 (0 N)
- ⋯ DYSS-7-5 (100 N)
- - - DYSS-7-5 (180 N)
- ⋯ DYSS-8-8 (0 N)
- - - DYSS-8-8 (100 N)
- - - DYSS-8-8 (200 N)

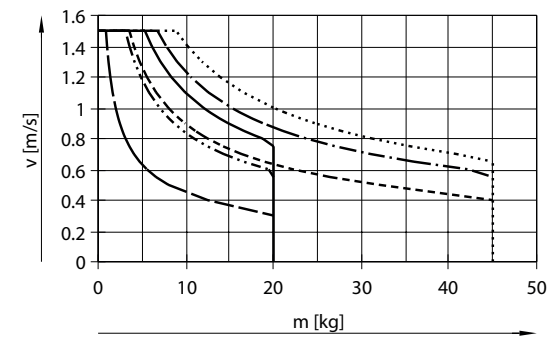

- DYSS-10-10 (0 N)
- ⋯ DYSS-10-10 (250 N)
- - - DYSS-10-10 (500 N)
- ⋯ DYSS-12-12 (0 N)
- - - DYSS-12-12 (200 N)
- - - DYSS-12-12 (500 N)

Data sheet

Dimensions

Download CAD data → www.festo.com

DYSS-2-4

DYSS-3-4/DYSS-4-4

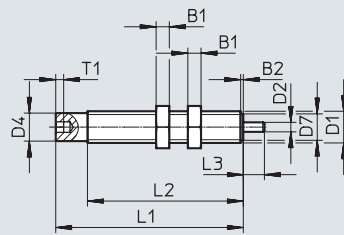
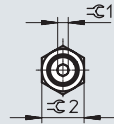
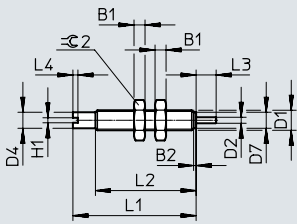

DYSS-...

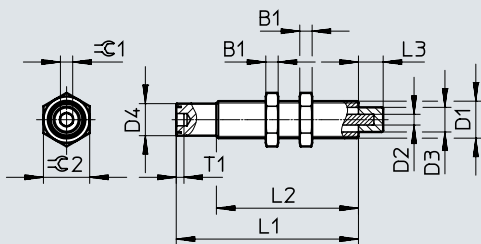

Note

- To increase the service life: Prevent dirt or liquids getting into the inner chamber of the piston via the piston rod (e.g. by using a cover).
- The piston rod must not be pushed beyond the stop surface
- The piston rod must not be pulled
- The screws in the internal hexa-socket must not be removed

Size	B1	D1	D2 ∅	D3 ∅	D4 ∅	H1	L1 ±0.2	L2 ±0.3
2	2.2	M4x0.5	1.2	-	3.2+0.1/-0.05	1	24.6	20.1
3	2.7	M5x0.5	1.5	-	4.3+0.1/-0.05	-	33.5	27.5
4	2.5	M6x0.5	1.8	-	5.3+0.1/-0.05	-	35.5	29.5
5	3	M8x1	2.5	5±0.1	6.7+0.1/-0.05	-	38.6	32.6
7	3.5	M10x1	3	6±0.1	8.6+0.1/-0.05	-	45.2	35.2
8	4	M12x1	3.5	8±0.2	10.4+0.15/-0.1	-	59	49
10	5	M14x1	4	10±0.2	12.5+0.15/-0.1	-	70	57
12	5	M16x1	5	12±0.2	14.5+0.15/-0.1	-	82.5	69.5

Size	L3	L4	T1	≈C1	Max. tightening torque ≈C1 [Nm]	≈C2	Max. tightening torque ≈C2 for nut [Nm]
2	4 ^{+0.5}	1	-	-	0.1	7	0.5
3	4 ^{+0.6}	-	1.5	2	0.5	8	1
4	4 ^{+0.6}	-	1.5	2	0.6	8	1
5	5 ^{+0.6}	-	2	2.5	1	10	2
7	5 ^{+0.6}	-	2.2	3	3	13	3
8	8 ^{+0.6}	-	2.5	4	5	15	5
10	10 ^{+0.8}	-	3.5	5	10	17	8
12	12 ^{+0.8}	-	3.5	5	16	19	20

Ordering data

Size	Part no.	Type
2	8081767	DYSS-2-4-Y1F
3	8111390	DYSS-3-4-Y1F-G2
4	8111391	DYSS-4-4-Y1F-G2
5	8081770	DYSS-5-5-Y1F
7	8069001	DYSS-7-5-Y1F
8	8069002	DYSS-8-8-Y1F
10	8069003	DYSS-10-10-Y1F
12	8069004	DYSS-12-12-Y1F

Peripherals overview and type codes

Peripherals overview

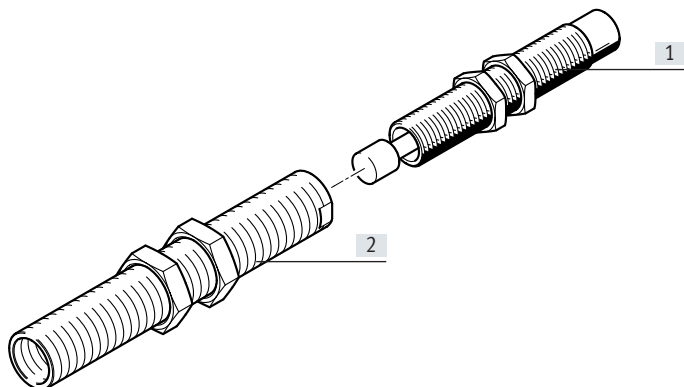

Accessories		
Type	Brief description	→ Page/Internet
[1] Shock absorber DYSW	Hydraulic shock absorber with slowly increasing cushioning force curve	34
[2] Reducing sleeve DAYH	To improve cushioning characteristics at low load, the installed shock absorber can be replaced with the next size down shock absorber using the reducing sleeve.	49

Type codes

001	Series
DYSW	Shock absorber



002	Size
4	4
5	5
7	7
8	8
10	10
12	12

003	Stroke
6	6
8	8
10	10
14	14
17	17
20	20

004	Geometric characteristics
Y1	Internal hex

005	Stop
F	With fixed stop

Data sheet

-  - Size
4 ... 12
-  - Stroke length
6 ... 20 mm



General technical data						
Size	4	5	7	8	10	12
Stroke [mm]	6	8	10	14	17	20
Mode of operation	Hydraulic shock absorber with spring return Single-acting, pushing					
Cushioning	Self-adjusting, soft characteristic curve					
Cushioning length [mm]	6	8	10	14	17	20
Type of mounting	With lock nut					
Impact velocity [m/s]	0.1 ... 2		0.1 ... 3			
Mounting position	Any					
Product weight [g]	6	11	21	42	67	91
Ambient temperature [°C]	-10 ... +80					
Corrosion resistance class CRC ¹⁾	2					

1) Corrosion resistance class CRC 2 to Festo standard FN 940070

Moderate corrosion stress. Indoor applications in which condensation can occur. External visible parts with primarily decorative surface requirements which are in direct contact with a normal industrial environment.

Reset time [s]						
Size	4	5	7	8	10	12
Reset time ¹⁾	≤ 0.2					≤ 0.3

1) The specified technical data refers to room temperature. At higher temperatures in the region of 80°C, the maximum mass and the cushioning energy must be reduced by approximately 50%. At -10°C, the reset time may be up to 1 second.

Forces [N]						
Size	4	5	7	8	10	12
Min. insertion force ¹⁾	6.5	7.5	10	18	25	35
Max. stop force ²⁾ in end positions (housing)	100	200	300	500	700	1000
Min. resetting force ³⁾	0.7	0.9	1.2	2.5	3.5	5

1) This is the minimum force that must be applied so that the shock absorber is pushed precisely into the retracted end position. This value is reduced accordingly with an extended external end position.

2) If the maximum stop force is exceeded, a fixed stop (e.g. YSRA) must be fitted 0.5 mm before the end of stroke.

3) This is the maximum force that can act on the piston rod, allowing the shock absorber to fully extend (e.g. extended stud).

Energies [J]						
Size	4	5	7	8	10	12
Max. energy absorption per stroke	0.8	1.3	2.5	4	8	12
Max. energy consumption per hour	7000	10000	15000	21000	30000	41000
Max. residual energy	0.006	0.01	0.01	0.02	0.03	0.05

Mass range [kg]						
Size	4	5	7	8	10	12
Mass range up to	1.2	2	5	10	20	30

Data sheet

Materials

Size	4	5	7	8	10	12
Buffer	Polyacetal					
Piston rod	High-alloy steel					
Housing	High-alloy steel				Galvanised steel	
Seals	Nitrile rubber					
Note on materials	Free of copper and PTFE					
	RoHS-compliant					

Selection graph for self-adjusting shock absorbers with progressive characteristics DYSW

Impact velocity v as a function of mass m

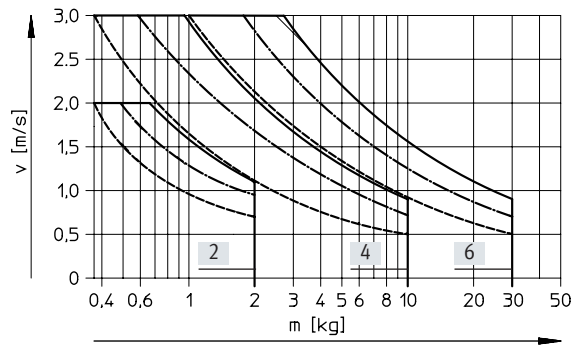
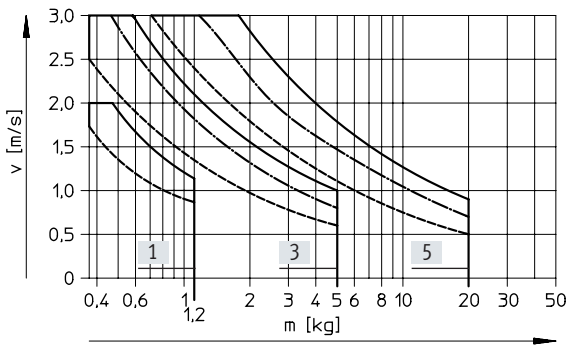

Three force curves are shown for each shock absorber. An average must be taken for intermediate values.

- [1] DYSW-4-6-Y1F
- [2] DYSW-5-8-Y1F
- [3] DYSW-7-10-Y1F

- [4] DYSW-8-14-Y1F
- [5] DYSW-10-17-Y1F
- [6] DYSW-12-20-Y1F

Shock absorber	Force -----	Force - - - - -	Force
DYSW-4-6-Y1F	0 N	-	50 N
DYSW-5-8-Y1F	0 N	50 N	100 N
DYSW-7-10-Y1F	0 N	75 N	150 N
DYSW-8-14-Y1F	0 N	100 N	200 N
DYSW-10-17-Y1F	0 N	150 N	300 N
DYSW-12-20-Y1F	0 N	200 N	400 N

Data sheet

Dimensions

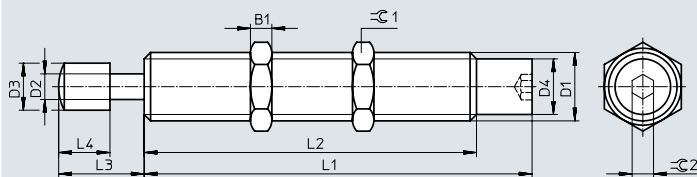
Download CAD data → www.festo.com

Shock absorber in end position

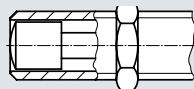
-  - **Note**

To increase the service life:
Prevent dirt or liquids getting into the inner chamber of the piston via the piston rod (e.g. by using a cover).

Size	B1	D1	D2 ∅	D3 ∅	D4 ∅	L1 +0.1
4	2.5	M6x0.5	2	3.5±0.05	5.35±0.05	35.5
5	3	M8x1	2.5	4.7±0.05	6.7±0.05	43.1
7	3.5	M10x1	3	6±0.1	8.6±0.05	52.05
8	4	M12x1	4	7±0.1	10.4±0.1	66.05
10	5	M14x1	5	9±0.1	12.4±0.1	77.55
12	5	M16x1	6	11±0.1	14.4±0.1	90.75

Size	L2 +0.3 -0.2	L3	L4	≈C1	≈C2	Max. tightening torque ≈C1 [Nm]
4	25.5	6+0.30/-0.24	4±0.05	8	2	1
5	33.1	8+0.32/-0.28	5.5±0.1	10	2.5	2
7	41.05	10+0.37/-0.28	7±0.2	13	3	3
8	53.05	14+0.37/-0.28	8±0.2	15	4	5
10	64.55	17+0.37/-0.28	10±0.2	17	4	8
12	77.75	20+0.45/-0.30	12±0.2	19	5	20

Ordering data

Size	Part no.	Type
4	548070	DYSW-4-6-Y1F
5	548071	DYSW-5-8-Y1F
7	548072	DYSW-7-10-Y1F
8	548073	DYSW-8-14-Y1F
10	548074	DYSW-10-17-Y1F
12	548075	DYSW-12-20-Y1F

Peripherals overview and type codes

Peripherals overview

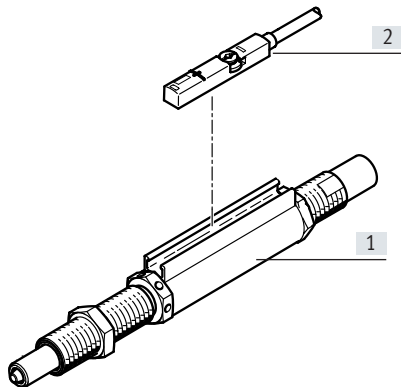

Accessories		
Type	Brief description	→ Page/Internet
[1] Stop element YSRWJ	Hydraulic shock absorber with progressive cushioning characteristic. The cushioning length is adjustable	38
[2] Proximity switch SME-/SMT-8	Sensing option for end positions	49

Type codes



001	Series
YSRWJ	Shock absorber

002	Size
5	5
7	7
8	8

003	Stroke
8	8
10	10
14	14

004	Position sensing
A	For proximity sensor

Data sheet

-  - Size
5 ... 8
-  - Stroke length
7.5 ... 13.5 mm

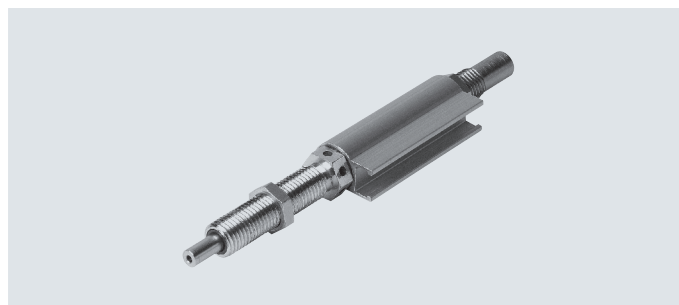

General technical data				
Size		5	7	8
Stroke	[mm]	8	10	14
Mode of operation	A piston rod in front of the shock absorber transfers the force to the shock absorber. The piston rod acts as an end stop and actuates the proximity switch via a magnet mounted on it			
	Single-acting, pushing			
Cushioning	Self-adjusting, soft characteristic curve			
Cushioning length	[mm]	8	10	14
Type of mounting	With lock nut			
Position sensing	Via proximity switch			
Impact velocity	[m/s]	0.05 ... 2	0.05 ... 3	
Repetition accuracy	[mm]	0.02		
Mounting position	Any			
Product weight	[g]	45	75	110
Ambient temperature	[°C]	0 ... +60		
Corrosion resistance class CRC ¹⁾		2		

1) Corrosion resistance class CRC 2 to Festo standard FN 940070

Moderate corrosion stress. Indoor applications in which condensation can occur. External visible parts with primarily decorative surface requirements which are in direct contact with a normal industrial environment.

Reset time [s]				
Size		5	7	8
Reset time ¹⁾		≤ 0.2		

1) The specified technical data refers to room temperature. At higher temperatures in the region of 80°C, the maximum mass and the cushioning energy must be reduced by approximately 50%. At 0°C, the reset time may be up to 1 second.

Forces [N]				
Size		5	7	8
Min. insertion force ¹⁾		5	18	80
Max. stop force ²⁾ in the end positions		200	300	500
Min. resetting force ³⁾		1.5	2	3.5

1) This is the minimum force that must be applied so that the shock absorber is pushed precisely into the retracted end position.

2) The max. stop force must not be exceeded.

3) This is the maximum force that can act on the piston rod, allowing the shock absorber to fully extend.

Energies [J]				
Size		5	7	8
Max. energy absorption per stroke		1	2	3
Max. energy consumption per hour		10000	15000	21000
Max. residual energy		0.01		0.02

Mass range [kg]				
Size		5	7	8
Mass range up to		2	5	10

Data sheet

Materials

Stop element	
Limit plunger	Reinforced stainless steel
Stop sleeve	Galvanised steel
Threaded barrel	Nickel-plated brass
Note on materials	Free of copper and PTFE
	RoHS-compliant

Selection graphs for stop elements with shock absorber YSRWJ

Impact velocity v as a function of mass m

YSRWJ-5-8-A

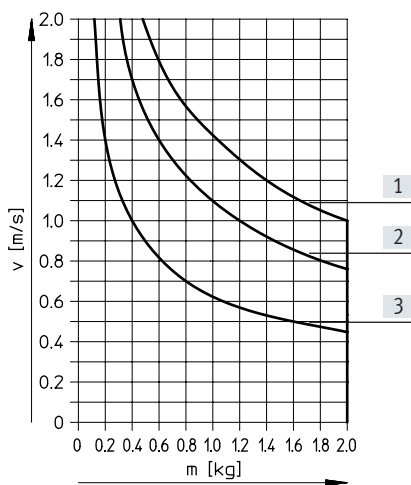

- [1] Without additional force
- [2] With additional force $A = 50$ N
- [3] With additional force $A = 100$ N

YSRWJ-7-10-A

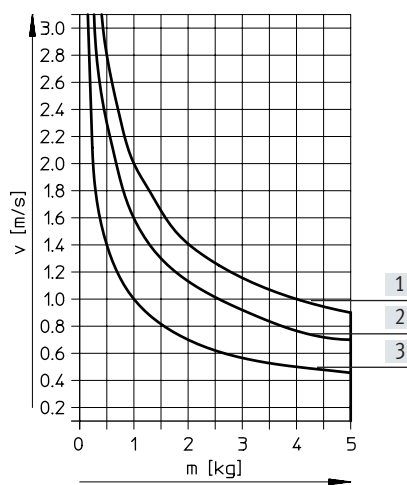

- [1] Without additional force
- [2] With additional force $A = 75$ N
- [3] With additional force $A = 150$ N

YSRWJ-8-14-A

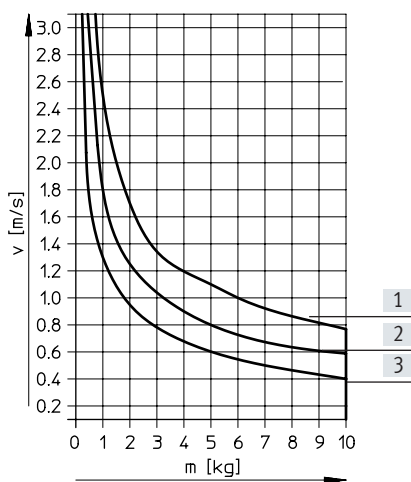

- [1] Without additional force
- [2] With additional force $A = 100$ N
- [3] With additional force $A = 150$ N

Data sheet

Mode of operation



- [1] Soft cushioning characteristics.
Cushioning stroke is adjustable
- [2] End-position sensing via proximity switch SME-/SMT-8 that can be integrated
- [3] Precision end-position adjustment
- [4] Precise end position using internal metallic end position

Dimensions

Download CAD data → www.festo.com

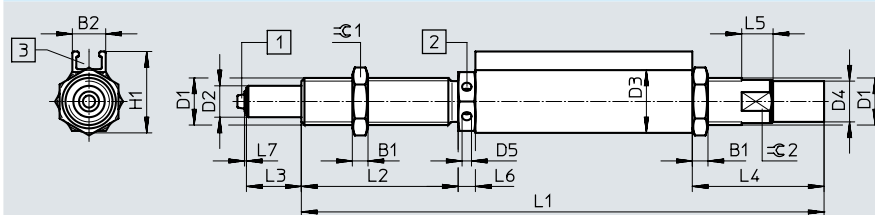

- [1] Rubber buffer, only for sizes: YSRWJ-7-10-A and YSRWJ-8-14-A
- [2] Precision end-position adjustment
- [3] Slot for proximity switch SME/SMT-8

Size	B1	B2	D1	D2	D3	D4	D5	H1	L1	L2
		+0.4			+0.1		+0.1	+0.3	+0.3/-0.1	+0.4
5	3	8.1	M8x1	4	12	6.7 ±0.05	2	16.5	97.4	32.5
7	3.5	8.5	M10x1	6	14	8.6 ±0.05	2.4	18.3	144.8	40
8	4	8.5	M12x1	8	16	10.4 ±0.1	2.4	20.75	133.3	40

Size	L3	L4	L5	L6	L7	$\varnothing 1$	$\varnothing 2$	Max. tightening torque $\varnothing 1$
		+0.45/-0.1	+0.5	+0.1/-0.55	+0.3			[Nm]
5	8 ±0.7/-0.55	21.6	5	4.4	0.5	10	7	7
7	10 ±0.8/-0.55	21.1	6	4	0.5	13	9	9
8	14 ±0.8/-0.55	33.6	8	4.4	0.5	15	11	11

Ordering data

Size	Part no.	Type
5	192968	YSRWJ-5-8-A
7	192967	YSRWJ-7-10-A
8	192966	YSRWJ-8-14-A

Peripherals overview and type codes

Peripherals overview

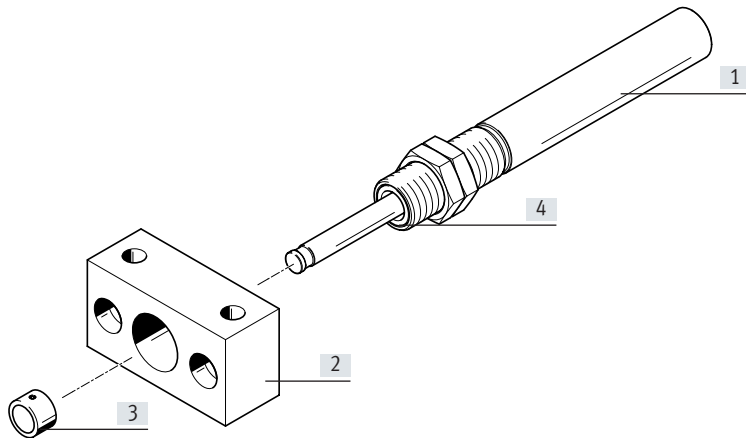

Accessories and special feature		
Type	Brief description	→ Page/Internet
[1] Hydraulic cushioning cylinder DYHR	Hydraulic cushioning cylinder with spring return for slow feed speeds	42
[2] Mounting flange YSRF	Mounting option for hydraulic cushioning cylinder	46
[3] Buffer YSRP	For protecting the piston rod	48
[4] Wiper seal; hardened piston rod	The wiper seal (prevents the ingress of dirt) and the hardened piston rod (protects against scratches) greatly increase the service life	-

Type codes



001	Series
DYHR	Hydraulic cushioning cylinder

002	Size
16	16
20	20
25	25
32	32

003	Stroke
20	20
25	25
40	40
50	50
60	60

004	Geometric characteristics
Y5	Internal hex for adjusting cushioning

Data sheet

-  - Size
 16 ... 32
-  - Stroke length
 20 ... 60 mm

**General technical data**

Size		16	20	25	32		
Stroke	[mm]	20	40	25	50	40	60
Mode of operation	Hydraulic cushioning cylinder with spring return Single-acting, pushing						
Braking speed	Adjustable						
Type of mounting	With lock nut						
Max. impact velocity	[m/s]	0.3					
Mounting position	Any						
Feed speed	[mm/s]	0.2 ... 100					
Product weight	[g]	190	255	360	440	720	1380
Ambient temperature	[°C]	0 ... +80					
Corrosion resistance class CRC ¹⁾		1					

1) Corrosion resistance class CRC 1 to Festo standard FN 940070

Low corrosion stress. Dry indoor application or transport and storage protection. Also applies to parts behind covers, in the non-visible interior area, and parts which are covered in the application (e.g. drive trunnions).

Reset times [s]

Size	16	20	25	32
Short stroke ¹⁾	≤ 0.4	≤ 0.5	≤ 0.8	≤ 1.2
Long stroke ¹⁾	≤ 0.8	≤ 1	-	-

1) Increased reset times must be expected at low temperatures (0°C). Up to 5 s for sizes 12 and 16, and up to 12 s for sizes 25 and 32.

Forces [N]

Size	16	20	25	32
Min. feed force ¹⁾	160	250	400	640
Max. feed force ²⁾	1600	2500	4000	6400
Resetting force ³⁾	5.4	9	12.5	18

1) Minimum force required for constant and accurately reproducible braking speed

2) Corresponds to max. force in the end position

3) With piston rod extended

Energies [J]

Size	16	20	25	32			
Stroke	[mm]	20	40	25	50	40	60
Max. energy absorption per stroke	32	64	62.5	125	160	384	
Max. energy consumption per hour	100000	150000	135000	200000	220000	330000	
Max. residual energy in the end position	0.16	0.32	0.32	0.8	0.8	2	

Data sheet

Materials

Hydraulic cushioning cylinder

[1] Piston rod	Hardened high-alloy steel
[2] Housing	Galvanised steel
- Seals	Nitrile rubber
Note on materials	RoHS-compliant

Braking speed v as a function of drive force F and flow control valve setting

DYHR-16

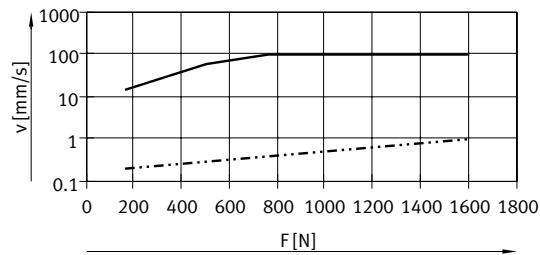

DYHR-20

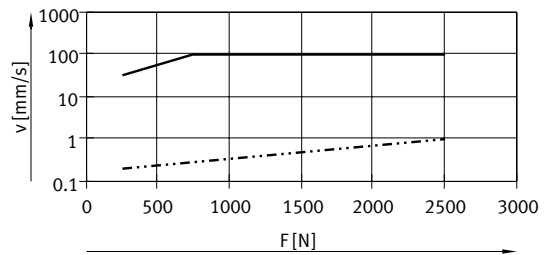

DYHR-25

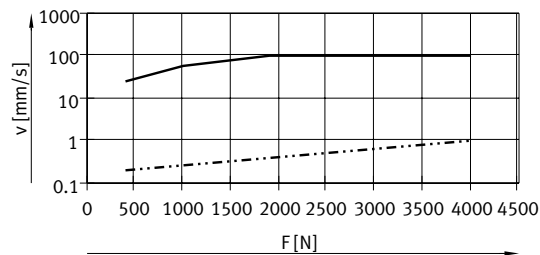

DYHR-32

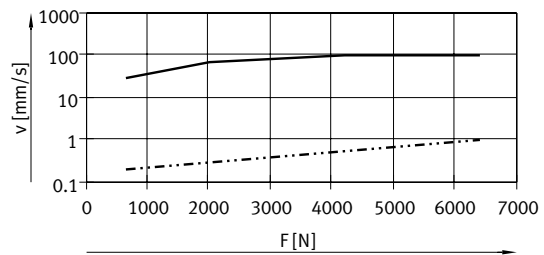

- Flow control valve open
- - - - - Flow control valve closed

Data sheet

Dimensions

Download CAD data → www.festo.com

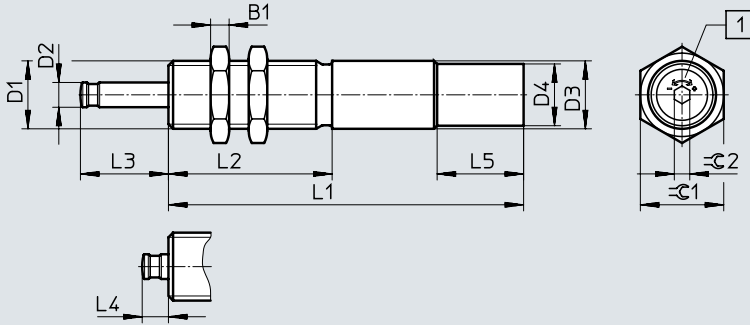

[1] Speed control

Size	Stroke [mm]	B1	D1	D2 \varnothing	D3 \varnothing +0.15/-0.1	D4 \varnothing +0.15	L1
16	20	6	M20x1.25	8	20	-	115±0.1
	40						150±0.1
20	25	8	M24x1.25	10	24	-	138±0.1
	50						181±0.1
25	40	10	M30x1.5	12	30	28.8	178±0.1
32	60	12	M37x1.5	15	37	34.8	230±0.15

Size	Stroke [mm]	L2 ±0.1	L3	L4	L5 ±0.2	$\varnothing 1$	$\varnothing 2$
16	20	53	28.5+0.4/-0.3	8.5+0.45/-0.4	-	24	5
	40		48.5+0.4/-0.3				
20	25	60	35.6+0.4/-0.3	10.6+0.45/-0.4	-	30	5
	50		60.6+0.4/-0.3				
25	40	80	52.8+0.4/-0.3	12.8+0.45/-0.4	28	36	6
32	60	108	76+0.5/-0.4	16+0.5/-0.4	28	46	6

Ordering data

Size	Stroke [mm]	Part no.	Type
16	20	1155690	DYHR-16-20-Y5
	40	1155691	DYHR-16-40-Y5
20	25	1155692	DYHR-20-25-Y5
	50	1155693	DYHR-20-50-Y5
25	40	1155694	DYHR-25-40-Y5
32	60	1155696	DYHR-32-60-Y5

Data sheet

Mounting flange YSRF/YSRF-C

Material:
Steel

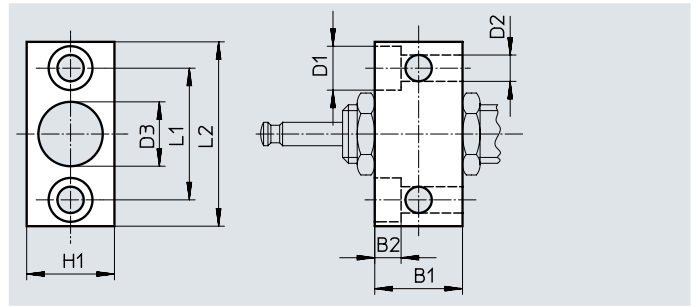
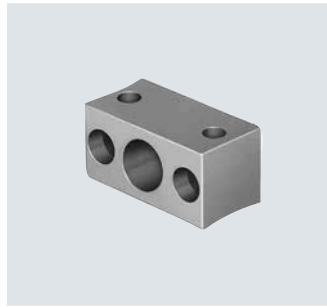

Combination options					
Cushioning components	DYSR...-		YSR-C	YSRW	DYHR
Mounting flange	Y5	Y5-T			
YSRF					
YSRF-8	–	–	■ ¹⁾	■ ¹⁾	–
YSRF-12	■	–	–	–	–
YSRF-16	■	–	–	–	■
YSRF-20	■	–	–	–	■
YSRF-25	■	–	■	–	■
YSRF-32	■	–	■	–	■
YSRF-C					
YSRF-8-C	■	–	■	■	–
YSRF-12-C	–	■	■	■	–
YSRF-16-C	–	■	■	■	–
YSRF-20-C	–	■	■	■	–

1) For shock absorber size $\varnothing 7$

Dimensions and ordering data

YSRF												
For size [mm]	B1	B2	D1	D2	D3	H1	L1	L2	CRC ¹⁾	Weight [g]	Part no.	Type
8	16	5.5	10	5.5	10.2	16	25	38	2	50	11681	YSRF-8
12	25	6.8	11	6.6	15.2	25	36	50	2	175	11682	YSRF-12
16	30	9	15	9	20.2	30	45	63	2	300	11683	YSRF-16
20	36	11	18	11	24.2	36	56	78	2	535	11684	YSRF-20
25	45	13	20	13.5	30.2	45	63	86	2	895	11685	YSRF-25
32	55	15	24	15.5	37.2	55	80	108	2	1730	11686	YSRF-32

1) Corrosion resistance class CRC 2 to Festo standard FN 940070

Moderate corrosion stress. Indoor applications in which condensation can occur. External visible parts with primarily decorative surface requirements which are in direct contact with a normal industrial environment.

YSRF-C												
For size [mm]	B1	B2	D1	D2	D3	H1	L1	L2	CRC ¹⁾	Weight [g]	Part no.	Type
8	20	5.5	10	5.5	12.2	20	28	41	2	90	34575	YSRF-8-C
12	25	6.8	11	6.6	16.2	25	36	50	2	180	34576	YSRF-12-C
16	32	9	15	9	22.2	32	45	63	2	330	34577	YSRF-16-C
20	40	11	18	11	26.2	40	56	78	2	700	34578	YSRF-20-C

1) Corrosion resistance class CRC 2 to Festo standard FN 940070

Moderate corrosion stress. Indoor applications in which condensation can occur. External visible parts with primarily decorative surface requirements which are in direct contact with a normal industrial environment.

Data sheet

Mounting flange YSRF-S-C

Material:

Aluminium, steel

Free of copper and PTFE

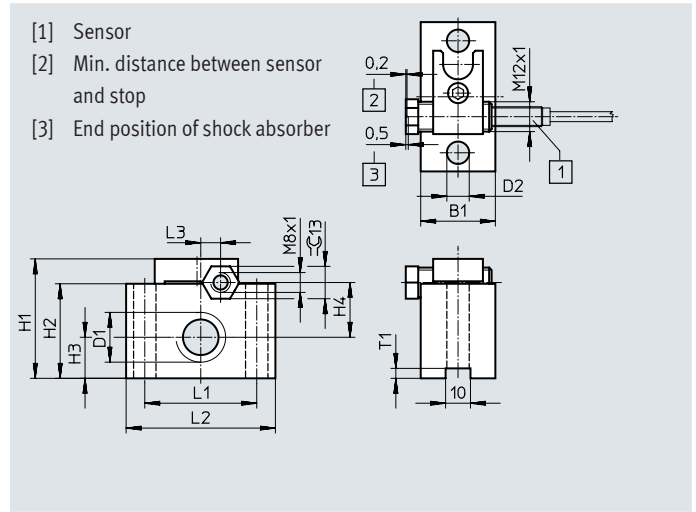

Combination options		YSR-C	YSRW
Cushioning components			
Mounting flange			
YSRF-S-8-C		■	■
YSRF-S-12-C		■	■
YSRF-S-16-C		■	■
YSRF-S-20-C		■	■

Dimensions and ordering data														
For size	B1	D1	D2 ∅	H1	H2	H3	H4	L1	L2	L3	T1	Weight [g]	Part no.	Type
[mm]														
8	20	M12x1	5.5	35	25	9.5	16	32	45	4	2	12	34579	YSRF-S-8-C
12	25	M16x1	6.6	42	32	12.5	20	36	50	3	4	130	34580	YSRF-S-12-C
16	30	M22x1.5	9	48	38	16.5	22	45	60	8	4	180	34581	YSRF-S-16-C
20	30	M26x1.5	11	52	42	19	23.5	56	80	11.5	4	250	34582	YSRF-S-20-C

 **Note**
Inductive sensors for position sensing → page 50

Data sheet

Buffer YSRP

Material:
Steel, polyurethane

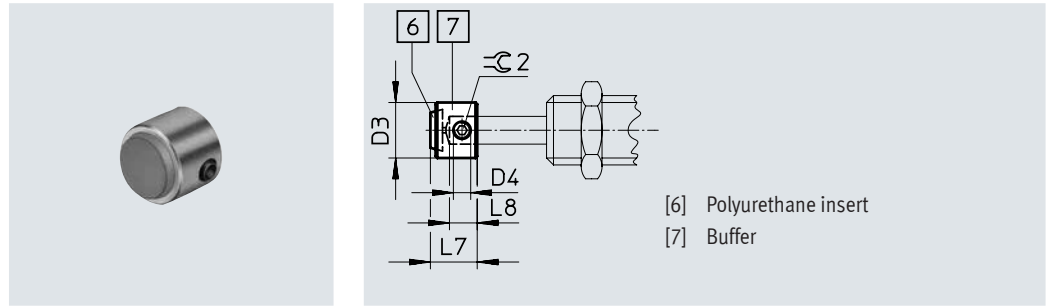

[6] Polyurethane insert
[7] Buffer

Dimensions and ordering data

For size [mm]	D3	D4	L7	L8	\approx 2	CRC ¹⁾	Weight [g]	Part no.	Type
8	8	M2	6.7	4	0.9	2	4	539638	YSRP-8
12	12	M4	10	6	2	2	7	11133	YSRP-12
16	16	M5	13.5	8	2.5	2	15	11134	YSRP-16
20	20	M6	17	10	3	2	27	11135	YSRP-20
25	25	M8	20.5	12	4	2	52	11136	YSRP-25
32	32	M8	26	15	4	2	110	11137	YSRP-32

1) Corrosion resistance class CRC 2 to Festo standard FN 940070

Moderate corrosion stress. Indoor applications in which condensation can occur. External visible parts with primarily decorative surface requirements which are in direct contact with a normal industrial environment.

End stop limiter YSRA-C

Material:
Steel

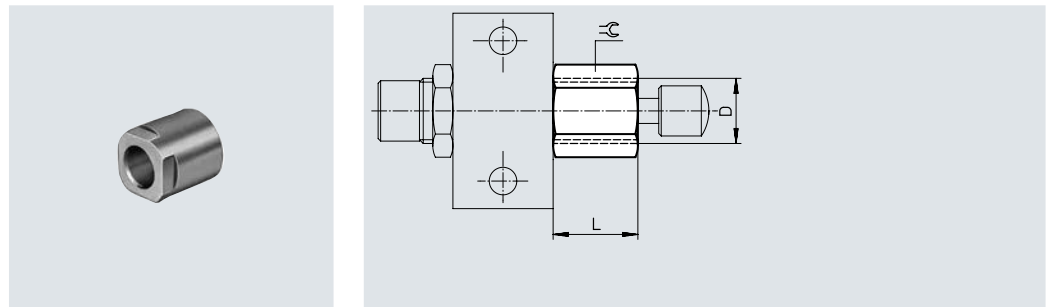

Dimensions and ordering data

For size [mm]	D	L	\approx 2	Weight [g]	Part no.	Type
7	M10x1	14.5	13	12	150932	YSRA-7-C
8	M12x1	18	15	28	150933	YSRA-8-C
12	M16x1	24.5	19	48	150934	YSRA-12-C

Data sheet

Reducing sleeve DAYH

Material:
Niro steel



To improve cushioning characteristics at low load, the installed shock absorber can be replaced with the next size down shock absorber using the reducing sleeve.

Installed shock absorber	Part no.	Reducing sleeve	Part no.	Next size down shock absorber
YSR...-C				
YSR-5-5-C	1165476	DAYH-4	540060	YSR-4-4-C
DYSC...				
DYSC-8-8-Y1F	1165484	DAYH-7	548012	DYSC-7-5-Y1F
DYSC-7-5-Y1F	1165480	DAYH-5	548011	DYSC-5-5-Y1F
DYSW...				
DYSW-12-20-Y1F	1165491	DAYH-10	548074	DYSW-10-17-Y1F
DYSW-10-17-Y1F	1165488	DAYH-8	548073	DYSW-8-14-Y1F
DYSW-8-14-Y1F	1165484	DAYH-7	548072	DYSW-7-10-Y1F
DYSW-7-10-Y1F	1165480	DAYH-5	548071	DYSW-5-8-Y1F
DYSW-5-8-Y1F	1165476	DAYH-4	548070	DYSW-4-6-Y1F

Ordering data – Proximity switch for T-slot, magneto-resistive

Data sheets → Internet: smt



Type of mounting	Switching output	Electrical connection	Cable length [m]	Part no.	Type
N/O contact					
Inserted in the slot from above, flush with the cylinder profile, short design	PNP	Cable, 3-wire	2.5	574335	SMT-8M-A-PS-24V-E-2.5-OE
		Plug M8x1, 3-pin	0.3	574334	SMT-8M-A-PS-24V-E-0.3-M8D
		Plug M12x1, 3-pin	0.3	574337	SMT-8M-A-PS-24V-E-0.3-M12
	NPN	Cable, 3-wire	2.5	574338	SMT-8M-A-NS-24V-E-2.5-OE
		Plug M8x1, 3-pin	0.3	574339	SMT-8M-A-NS-24V-E-0.3-M8D
N/C contact					
Inserted in the slot from above, flush with the cylinder profile, short design	PNP	Cable, 3-wire	7.5	574340	SMT-8M-A-PO-24V-E-7.5-OE

Ordering data – Proximity switch for T-slot, magnetic reed

Data sheets → Internet: sme

Type of mounting	Switching output	Electrical connection	Cable length [m]	Part no.	Type
N/O contact					
Inserted in the slot from above, flush with the cylinder profile	Contacting	Cable, 3-wire	2.5	543862	SME-8M-DS-24V-K-2.5-OE
		Plug M8x1, 3-pin	0.3	543861	SME-8M-DS-24V-K-0.3-M8D
Inserted in the slot lengthwise, flush with the cylinder profile	Contacting	Cable, 3-wire	2.5	150855	SME-8-K-LED-24
		Plug M8x1, 3-pin	0.3	150857	SME-8-S-LED-24
N/C contact					
Inserted in the slot lengthwise, flush with the cylinder profile	Contacting	Cable, 3-wire	7.5	160251	SME-8-O-K-LED-24

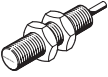
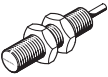
Data sheet

Ordering data – Inductive sensors M8, for mounting flange YSRF-S-C							Data sheets → Internet: sien
	Electrical connection	Plug M8	Switching output	LED	Cable length [m]	Part no.	Type
N/O contact							
	3-wire	–	PNP	■	2.5	150386	SIEN-M8B-PS-K-L
	–	3-pin	PNP	■	–	150387	SIEN-M8B-PS-S-L
N/C contact							
	3-wire	–	PNP	■	2.5	150390	SIEN-M8B-PO-K-L
	–	3-pin	PNP	■	–	150391	SIEN-M8B-PO-S-L
Ordering data – Connecting cables							Data sheets → Internet: nebu
	Electrical connection, left	Electrical connection, right	Cable length [m]	Part no.	Type		
	Straight socket, M8x1, 3-pin	Cable, open end, 3-wire	2.5	541333	NEBU-M8G3-K-2.5-LE3		
			5	541334	NEBU-M8G3-K-5-LE3		
	Angled socket, M8x1, 3-pin	Cable, open end, 3-wire	2.5	541338	NEBU-M8W3-K-2.5-LE3		
			5	541341	NEBU-M8W3-K-5-LE3		

Data sheet

This selection aid helps you determine the right shock absorber for every application.

When choosing the correct shock absorber, we recommend that you proceed as follows:

When selecting a shock absorber for your application, you must ensure that the following values are not exceeded:

The (angular) speed used in the formulas is the speed on impact with the shock absorber. This depends on the dynamic performance of the drive component and can thus only be determined with difficulty.

It is better to determine the average speed ($v_m = s/t$ or $\omega_m = \varphi/t$).

The following formulas are required for the calculation:

The following applies in addition for rotary motion:

The following abbreviations are used:

1. Determine the following at the moment of impact:

- Force (A)
- Equivalent mass m_{equiv}
- Impact velocity (v)

- Permissible energy utilisation per stroke:

$$W_{min.} = 25\%$$

$$W_{max.} = 100\%$$

- Recommended energy utilisation per stroke:

$$W_{opt.} = 50\% \dots 100\%$$

To prevent damage to the drive, for safety reasons the following values should be used for calculation:

$$v = 1.25 \dots 2 v_m$$

$$\omega = 1.25 \dots 2 \omega_m$$

Typical values for linear movements:

Factor of 2 for strokes < 50 mm,

Factor of 1.5 for strokes > 50 mm and < 100 mm,

Factor of 1.25 for strokes > 100 mm.

$$A = F + G$$

$$A = F + m \times g \times \sin \alpha$$

$$W_{total} = 1/2 \times m \times v^2 + A \times s < W_{max.}$$

$$W_h = W_{total} \times \text{strokes} / \text{hour} < W_{hmax.}$$

$$m_{equiv.} = 1/R^2$$

$$v = \omega \times R$$

$$A = M/R + m \times g \times \sin \alpha \times a/R$$

A = Additional force = F + G [N]

F = Cylinder force minus frictional force [N]

G = Weight force
= $m \times g \times \sin \alpha$

Special cases:

$\alpha = 0^\circ$: Horizontal movement
G = 0

$\alpha = 90^\circ$: Downward movement
G = $m \times g$

$\alpha = 90^\circ$: Upward movement
G = $-m \times g$

2. Select the shock absorber from the graphs on the following pages.

3. Check the selected shock absorber using the max. cushioning energy ($W_{max.}$)

- Max. energy absorption per hour

- Max. residual energy

- Max. stop force in the end position

As the (angular) speed is squared in the calculation, the expected error increases considerably. The calculation can therefore only be taken into consideration as an approximate figure. However, the safety factor ensures that it is not possible to select a shock absorber that is too small.

v = Impact velocity [m/s]

$m_{equiv.}$ = Equivalent mass [kg]

g = Acceleration due to gravity
9.81 [m/s²]

s = Shock absorber stroke [m]

α = Impact angle [°]

W_{total} = Cushioning work/stroke [J]

W_h = Cushioning work/hour [J]

J = Mass moment of inertia
[kg x m²]

R = Distance between the pivot point of mass and shock absorber [m]

ω = Angular speed [rad/s]

M = Drive torque [Nm]

a = Distance between the centre of gravity of mass and the pivot point

Data sheet

Sizing example for linear motion

The procedure for selecting a shock absorber is illustrated using the adjacent diagram as an example:

$$A = F + m \times g \times \sin \alpha$$

$$= 190 \text{ N} + 50 \times 9.81 \times \sin \alpha$$

$$= 537 \text{ N}$$

$$m_{\text{equiv.}} = m = 50 \text{ kg}$$

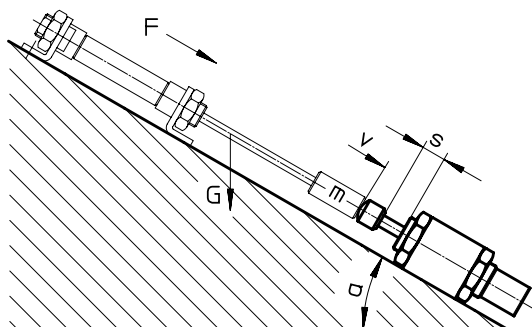

$$m = 50 \text{ kg}$$

$$v = 1.5 \text{ m/s}$$

$$\alpha = 45^\circ$$

$$F = 190 \text{ N}$$

(\varnothing 20 mm for $p = 6$ bar,
1800 strokes per hour)

When selecting the shock absorbers from the graphs (see data sheets), the curve immediately to the right of the point of intersection of the equivalent mass ($m_{\text{equiv.}}$) and the impact velocity (v) determines the force (A). The curves move to the left as the additional force increases.

Three force curves are shown for each shock absorber. An average must be taken for intermediate values. As the graphs show (solid line), shock absorbers DYSR-25-40 and YSR-25-40-C can be considered here.

It is yet to be determined whether the permissible cushioning work ($W_{\text{max.}}$) and the cushioning work per hour ($W_{\text{hmax.}}$) have been exceeded. The max. permissible values and the stroke length (s) can be found in the tables (below the graphs).

Test:

$$W_{\text{total}} = 1/2 \times m \times v^2 + A \times s$$

$$= (1/2 \times 50 \times 1.5^2 + 537 \times 0.04) \text{ Nm} = 78 \text{ J}$$

$$W_{\text{h}} = W_{\text{total}} \times \text{strokes/h}$$

$$= 78 \text{ Nm} \times 1\,800$$

$$= 140\,000 \text{ J}$$

Both shock absorbers are suitable for the above application. Additional selection criteria include possibility of adjustment, and size.

Result	DYSR-25-40	YSR-25-40-C
W_{total}	78 J	78 J
W_{h}	140000 J	140000 J
$W_{\text{max.}}^{1)}$	160 J > W_{total}	160 J > W_{total}
$W_{\text{hmax.}}$	220000 > $W_{\text{max.}}$	150000 > $W_{\text{max.}}$

1) In both cases, utilisation is 49%.

Data sheet

Sizing example for rotary motion

Example for rotary motion:

$$m_{\text{equiv.}} = J/R^2 = 8 \text{ kg}$$

$$v = \omega \times R$$

$$A = M/R = 40 \text{ N}$$

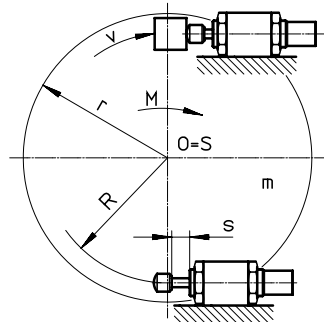

$$J = 2 \text{ kg m}^2$$

$$\omega = 4 \text{ rad/s}$$

$$R = 0.5 \text{ m}$$

$$M = 20 \text{ Nm}$$

900 strokes per hour

When selecting the shock absorbers from the graphs (see data sheets), the curve immediately to the right of the point of intersection of the equivalent mass ($m_{\text{equiv.}}$) and the impact velocity (v) determines the force (A). The curves move to the left as the additional force increases. Three force curves are shown for each shock absorber. An average must be taken for intermediate values. As the graphs show (dashed line), shock absorbers DYSR-16-20 and YSR-16-20-C are can be considered.

It is yet to be determined whether the permissible cushioning work ($W_{\text{max.}}$) and the cushioning work per hour ($W_{\text{hmax.}}$) have been exceeded. The max. permissible values and the stroke length (s) can be found in the tables (below the graphs).

Comment: For rotary applications, the impact angle must be taken into account.

Test:

$$\begin{aligned} W_{\text{total}} &= 1/2 \times m \times v^2 + A \times s \\ &= (1/2 \times 8 \times 2^2 + \\ &40 \times 0.02) \text{ J} = 17 \text{ J} \end{aligned}$$

$$\begin{aligned} W_{\text{h}} &= W_{\text{total}} \times \text{strokes/h} \\ &= 17 \text{ J} \times 900 \\ &= 15\,300 \text{ J} \end{aligned}$$

Both shock absorbers are suitable for the above application.

Additional selection criteria include possibility of adjustment, and size.

Result	DYSR-16-20 ³⁾	YSR-16-20-C
W_{total}	17 J	17 J
W_{h}	15 300 J	15 300 J
$W_{\text{max.}}$	32 J > W_{total} ¹⁾	30 J > W_{total} ²⁾
$W_{\text{hmax.}}$	100000 > $W_{\text{max.}}$	64000 > $W_{\text{max.}}$

- 1) Utilisation is 53%.
- 2) Utilisation is 57%.
- 3) Operated without buffer.

Festo - Your Partner in Automation



1 Festo Inc.
5300 Explorer Drive
Mississauga, ON L4W 5G4
Canada

Festo Customer Interaction Center
Tel: 1 877 463 3786
Fax: 1 877 393 3786
Email: customer.service.ca@festo.com



2 Festo Pneumatic
Av. Ceylán 3,
Col. Tequesquináhuac
54020 Tlalneptla,
Estado de México

Multinational Contact Center
01 800 337 8669
ventas.mexico@festo.com



3 Festo Corporation
1377 Motor Parkway
Suite 310
Islandia, NY 11749

Festo Customer Interaction Center
1 800 993 3786
1 800 963 3786
customer.service.us@festo.com



4 Regional Service Center
7777 Columbia Road
Mason, OH 45040

Connect with us



www.festo.com/socialmedia



www.festo.com

Subject to change