



Every part matters

EN

### Installation & Operating Instructions DIGITAL MULTI-FUNCTION INSTRUMENT Programmable Multi-function Digital Panel Meter

#### Article codes

136-5390 Digital AC Ammeter, 48x96, 3Phase, 1 or 5 Amps AC, Supply 40-300V ac/dc

136-5391 Digital AC Ammeter, 96x96, 3Phase, 1 or 5 Amps AC, Supply 40-300V ac/dc

136-5393 Digital AC Voltmeter, 48x96, 3Phase, 100-500VLL (57.7-288V L-N) AC, Supply 40-300V ac/dc

136-5394 Digital AC Voltmeter, 96x96, 3Phase, 100-500VLL (57.7-288V L-N) AC, Supply 40-300V ac/dc

#### Available Models:

1. 136-5394 Digital AC Voltmeter 96x96 with 14mm Display

2. 136-5391 Digital AC Ammeter 96x96 with 14mm Display



3. 136-5393 Digital AC Voltmeter 48x96

4. 136-5390 Digital AC Ammeter 48x96



### 1. Introduction

This RS Pro Series is a panel mounted 96 x 96mm and 48x96mm Digital Panel Meters (DPM) for the measurement of AC Voltage and current in 3 phase and single phase systems. The instrument integrates accurate measurement technology. The measurements are True RMS up to 15th Harmonic. The parameters are displayed with Ultra high brightness LED display with 14mm Digit height options.



Programmable DPM can be configured and Programmed at site for the following : PT Primary, PT Secondary,

CT Primary, CT secondary and System type 3 phase 3W or 4W or single phase System.

The front panel has two push buttons for user interface to scroll through the available parameters the two keys has function as follow :

1. Scrolls through parameter in upward sequence. Display sequence Digital AC Voltmeter models 136-5393 & 136-5394 : VR (VL1), VY (VL2), VB (VL3), VRY (VL1-L2), VYB(VL2-L3), VBR VL3-L1), Vsys, max value, min value and then back to VR (VL1).

Display sequence Digital AC Ammeter models 136-5390 & 136-5391 : IR (IL1), IY (IL2), IB (IL3), Isys, max value Min value and back to IR (IL1).

2. Scrolls the parameters in Reverse of above sequence.

The DPM 14mm LED Display, enables the user to take readings from long distances. The unit of display is illuminated from back side with bright LEDs, which overcomes the problem with conventional LED annunciators that could not be clearly understood the parameter being displayed from a distance.

TABLE 1: Parameters Displayed with Digital AC Voltmeter models 136-5393 & 136-5394

Measured Parameters	Unit of measurement
Voltage VR (VL1)	Volts
Voltage VY (VL2)	Volts
Voltage VB (VL3)	Volts
Voltage YR-Y (VL1-L2)	Volts
Voltage YY-B (VL2-L3)	Volts
Voltage VB-R (VL3-L1)	Volts
System Voltage	Volts
System Voltage max. Value (Hi)	Volts
System Voltage min. Value (Lo)	Volts

TABLE 1: Parameters Displayed with Digital AC Ammeter models 136-5390 & 136-5391

Measured Parameters	Unit of measurement
Current IR (IL1)	Amp
Current IY (IL2)	Amp
Current IB (IL3)	Amp
System Current	Amp
System Current max. Value (Hi)	Amp
System Current min. Value (Lo)	Amp

### 2. Measurement Reading Screens

In normal operation the user is presented with the measurement reading screens. These screens may be scrolled through one at a time in incremental order by pressing the key and in decrementing order by pressing key.

#### A. Display Screens of Digital AC Voltmeter models 136-5393 & 136-5394 :

Screen 1: Voltage R (L1) Phase

Screen 2 : Voltage Y (L2) Phase

Screen 3 : Voltage B (L3) Phase



Screen 4 : Line to Line Voltage (Voltage between R (L1) and Y (L2) phase)

Screen 5 : Line to Line Voltage (Voltage between Y (L2) and B (L3) phase)

Screen 6 : Line to Line Voltage (Voltage between B (L3) and R (L1) phase)



Screen 7 : System Voltage

Screen 8 : System Voltage max Value. Value displayed after "Hi" flashing on Display

Screen 9 : System Voltage min Value. Value displayed after "Lo" flashing on Display



#### A. Screens of Digital AC Ammeter models 136-5390 & 136-5391 :

Screen 1: Current R (L1) Phase

Screen 2 : Current Y (L2) Phase

Screen 3 : Current B (L3) Phase



Screen 4 : System Current



Screen 5 : System Current Max. Value. Value displayed after "Hi" flashing on Display



Screen 6 : System Current min. Value. Value displayed after "Lo"flashing on Display



### 3. Programming

The following sections comprise step by step procedures for configuring the RS Pro DPM's for individual user requirements.

To access tile set-up screens press and hold the and Keys Simultaneously.

This will take tile User into the Password Entry Screen Followed by "CodE" on Display (Section 3.1).

#### 3.1. Password Protection

Password protection can be enabled to prevent unauthorised access to set-up screens. By default password protection is not enabled.

Password protection is enabled by selecting a four digit number other than 0000. Setting a password of 0000 disables the password protection.



Password Entry :

Enter Password, prompt for first digit. (\*Denotes that decimal point will be flashing).

Press the key to scroll the value of the first dig from 0 to 9, the value will wrap from 9 round to 0.

Press the key to advance to next digit.

In the case, where the Password is "0000" pressing the key when prompted for the first digit will advance to the "Password Confirmed" screen.

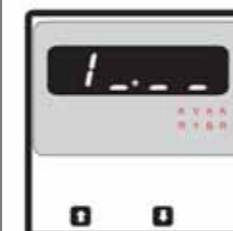

Enter Password, first digit entered, prompt for Second digit. (\*Denotes that decimal point will be flashing).

Use the key to scroll the value of the second digit from 0 through to 9, the value will wrap from 9 round to 0. Press the key to advance to next digit.

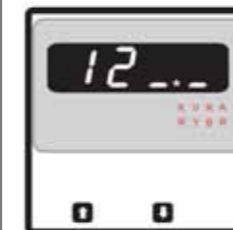

Enter Password,second digit entered, prompt for Third digit. (\*Denotes that decimal point will be flashing).

Use the key to scroll the value of the third digit from 0 through to 9, the value will wrap from 9 round to 0. Press the key to advance to next digit.



Enter Password, third digit entered, prompt for Fourth digit. (\*Denotes that decimal point will be flashing).

Use the key to scroll the value of the fourth digit from 0 through to 9, the value will wrap from 9 round to 0. Press the key to advance to next digit.



Enter Password, fourth digit entered, awaiting verification of the password.



Password confirmed.

Pressing key will advance to the 'New Password I change Password' entry stage.

Pressing the key will advance to the System Type Selection screen (See section 3.2).

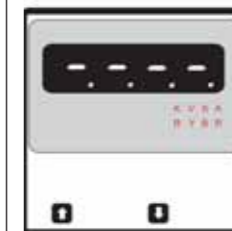

Password Incorrect.

This screen indicates that the unit has not accepted the Password entered.

Pressing the key will return to the Enter Password stage.

Pressing the key exits the Password menu and returns to the Measurement mode.

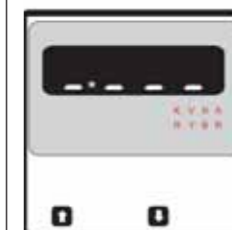

New/ Change Password

(\*Decimal point indicates that this will be flashing). Pressing the key will scroll the value of the first digit from 0 through to 9, the value will wrap from 9 round to 0.

Pressing the key to advance the operation to the next digit and sets the first digit.

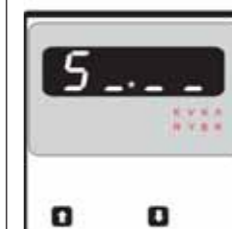

New/ Change Password, first digit entered, prompting for second digit. (\*Decimal point indicates that this will be flashing).

Pressing the key will scroll the value of the Second digit from 0 through to 9, the value will wrap from 9 round to 0.

Pressing the key to advance the operation to the next digit and sets the second digit,



New/ Change Password, second digit entered, prompting for third digit. (\*decimal point indicates that this will be flashing).

Pressing the key will scroll the value of the third digit from 0 through to 9, the value will wrap from 9 round to 0. Pressing the key to advance the operation to the next digit and sets the third digit,



New/ Change Password, third digit entered, prompting for fourth digit. (\*denotes that decimal point will be flashing). Pressing the key will scroll the value of the fourth digit from 0 through to 9, the value will wrap from 9 round to 0.

Pressing the key to advance the operation to the "New Password Confirmation" screen and sets the fourth digit,



New/ Change Password, fourth digit entered, Awaiting for confirmation

Pressing the key to advance the operation to the "New Password Confirmation" screen and sets the fourth digit,

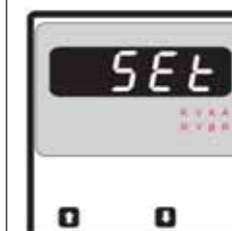

New Password confirmation

Pressing the key will return to the "New/Change Password".

Pressing the key will Set the new Password and advances to the Set up screen. (see section 3.2).



### 3.2 Set Up Screens

#### 3.2.1. System Type



This screen is Displayed after entering password followed by "Sys" on Display.

This screen is used to set the system type. System type "3" for 3 phase 3 wire & "4" for 3 phase 4 wire system & "1" for Single phase system.

Pressing " $\leftarrow$ " key accepts present value and advances to "Potential transformer Primary value edit" menu (section 3.2.2) for Digital AC Voltmeter models 136-5393 & 136-5394 or to "Current Transformer Primary value edit" menu (section 3.2.4) For Digital AC Ammeter models 136-5390 & 136-5391.

Pressing " $\rightarrow$ " Key will enter the System type edit Mode and scroll the values through values available.



Pressing " $\leftarrow$ " Key advances to the system type Confirmation menu.

#### System Type Confirmation

This screen will appear following the edit of system type in above screen.

Pressing the " $\leftarrow$ " key set the displayed value and will advance to 'Potential Transformer Primary Value Edit menu. (See section 3.2.2)

Pressing the " $\rightarrow$ " key re-enter System type edit Menu.

#### 3.2.2. Potential Transformer Primary Value (for Digital AC Voltmeter models 136-5393 & 136-5394)

The nominal full scale voltage which will be displayed as the Line to Line voltage for all system types. This screen is displayed followed by "PtPr" on display and enables user to set any PT Primary value from 100VL-L to 999kVL-L.

Note : PT Values must be set as Line to Line Voltage for Primary as well as Secondary for all system types.



Pressing the " $\leftarrow$ " key accepts the present value and advances to the "Potential Transformer secondary value Edit" menu. (See Section 3.2.3)

Pressing the " $\rightarrow$ " key will enter the "Potential transformer Primary Value Multiplier Selection.

Initially the "multiplier must be selected. Pressing the " $\rightarrow$ " Key will move the decimal point position to the right Side and show # # #. after which it will again return to

#. ##with Annunciation of "K", which indicates the value in kV.

Pressing the " $\leftarrow$ " key accepts the present multiplier (Decimal Point position) and advances to the "Potential Transformer value Edit" menu.



#### Potential Transformer value Edit

Pressing the " $\rightarrow$ " key will scroll the value of the most significant digit (100s) from 0 through to 9.

Pressing the " $\leftarrow$ " key accepts the present value at the cursor position and advances the cursor to the next Less significant digit

Note : the flashing decimal point indicates the cursor position, a steady decimal point will be present to identify the scaling of the number until the cursor position coincides with the steady decimal point position. At this stage the decimal point will be flashing.

When the least significant digit has been set, pressing the " $\leftarrow$ " key will advance to the "Potential transformer Primary Value Confirmation" screen.

Screen showing display of 11.0 kV (i.e. 11000 Volts) indicating steady decimal point and cursor flashing at the "tens" position as shown in above screen.



#### Potential Transformer Primary Value Confirmation

This screen will only appear following an edit of the Potential Transformer Primary Value followed by "ULL" on Display.

If the set value is to be corrected, pressing the " $\rightarrow$ " key will return to the "Potential Transformer Primary Value Edit" stage.

Pressing the " $\leftarrow$ " key sets the value and then advance to the Potential Transformer Secondary Value edit screen (See section 3.2.3.)

#### 3.2.3 Potential Transformer Secondary Value (for Digital AC Voltmeter models 136-5393 & 136-5394)



This screen is displayed after PT primary value set Followed by "Pt-S" it automatically goes to value edit . Pressing " $\leftarrow$ " key accepts the present value and then Advances to RESET menu (section 3.2.6).

Pressing the " $\rightarrow$ " key will enter the PT secondary value edit mode. \*denotes that the decimal point will Be flashing.

Pressing " $\rightarrow$ " will scroll the digit value 0 through 9 and back to 0, except Most Significant Digit, in which the

Value will be scrolled from 1 through 5 and back to 1.

Secondary value can be set from 100VL-L. to 500VL-L.

Pressing the " $\leftarrow$ " key will move cursor to next Digit. When Value of Least significant digit is set pressing " $\rightarrow$ " Will enter Secondary value confirmation screen.



#### PT secondary value Confirmation

This screen will appear following the edit of PT secondary in above screen.

Pressing the " $\leftarrow$ " key set the value and will advance to Reset of min/max value section menu. (See section 3.2.6)

Pressing the " $\rightarrow$ " key re-enter Potential Transformer Value edit menu.

#### 3.2.4 Current Transformer Primary Value (for Digital AC Ammeter models 136-5390 & 136-5391)

The nominal full scale Current which will be displayed phase current for both system types. This screen enables user to display Phase current inclusive of any CT Ratio 1 upto 999kA.



Pressing the " $\leftarrow$ " key accepts the present value and advances to the "Current Transformer secondary value Edit" menu. (See Section 3.2.5)

Pressing the " $\rightarrow$ " key will shift decimal point position from 100s to 1s digit. After 1s position it again shifts the position to 100s digit with annunciation of "K". It indicates the value in kA.

Pressing the " $\leftarrow$ " key accepts the decimal point position

and enters into Current Transformer Primary value edit. value of CT primary less than 1 entered then it automatically update CT primary as 1A.



#### Current Transformer value Edit

Pressing the " $\rightarrow$ " key will scroll the value of the most significant digit (100s) from 0 through to 9.

Pressing the " $\leftarrow$ " key accepts the present value at The cursor position and advances the cursor to the next Least significant digit.

Note : the flashing decimal point indicates the cursor position, a steady decimal point will be present to identify the scaling of the number until the cursor position coincides with the steady decimal point position. At this stage the decimal point will flash.

When the least significant digit has been set, pressing the " $\leftarrow$ " key will advance to the "Current transformer Primary Value Confirmation" screen.



#### Current Transformer Primary Value Confirmation

This screen will only appear following an edit of the Current Transformer Primary Value.

If the set value is to be corrected, pressing the " $\rightarrow$ " Key will return to the "Current Transformer Primary Value Edit" stage.

Pressing the " $\leftarrow$ " key sets the value and then advance to the Current Transformer Secondary Value edit screen (See section 3.2.5)

#### 3.2.5 Current Transformer Secondary Value (for Digital AC Ammeter models 136-5390 & 136-5391)



This screen is displayed after CT primary value set Followed by 'ct-s' on display.

Screen Pressing " $\leftarrow$ " key accepts the present value and then advances to the set menu (section 3.2.6). Pressing the " $\rightarrow$ " key will scroll between 1 and 5.

When desired Current transformer secondary value selected on display, pressing " $\leftarrow$ " will enter to CT secondary value confirmation screen.

#### CT secondary value Confirmation

This screen will appear following the edit of CT secondary in above screen.

Pressing the " $\leftarrow$ " key set the value and will advance to Reset menu (See section 3.2.6)

Pressing the " $\rightarrow$ " key re-enter Current Transformer Value edit menu.



#### 3.2.6 RESET of min/ max Values



This screen is displayed after CT/PT secondary set followed by "RESET" on Display.

Pressing " $\rightarrow$ " key enters into Reset menu and scrolls between the parameters as shown in the screens with pressing the key again.

Pressing " $\leftarrow$ " key enters Screen Auto or fixed selection menu (section 3.2.7)

By selecting the parameters it resets the respective parameters as follow:

None : No parameter set

ALL : Both min and max values reset Hi : max value reset

Lo : min value reset

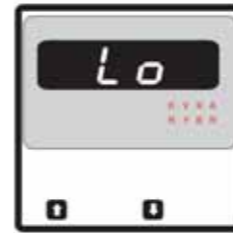

Pressing " $\rightarrow$ " key scrolls between the screens.

Pressing " $\leftarrow$ " selects the displayed parameter and enters to Reset parameter confirmation Screen.



#### Reset parameter confirmation

Pressing " $\rightarrow$ " key re-enters reset menu.

Pressing " $\leftarrow$ " resets the selected parameter and enters to Screen Auto scrolling or fixed. Selection menu (section 3.2.7).

#### 3.2.7 Selection of Auto Scrolling or fixed Screen



This Screen will display after RESET of minimax value Confirmation followed by "AUTO" Display.

Pressing the " $\rightarrow$ " key will scroll between "Yes" and "No". Select 'Yes' for Autoscrolling of parameter display and Select "No" for fixed display screen.

Pressing the " $\leftarrow$ " key will enter into Screen selection Confirmation screen.



#### Auto/ Fixed Screen Confirmation

Pressing the " $\leftarrow$ " key set the selected option and Exit set up with entering into measurement mode.

Pressing the " $\rightarrow$ " key re-enter Screen selection menu.

## 4. Installation

Mounting of RS Pro DPM's is featured with easy "Clip- in" mounting. Push the meter in panel slot (size 92 x92 mm), it will click fit into panel with the four integral retention clips on two sides of meter.

If required Additional support is provided with swivel screws (optional) as shown in figure.

As the front of the enclosure conforms to Ip50 it is protected from water spray from all directions, additional protection to the panel may be obtained by the use of an optional panel gasket. The terminals at the rear of the product Should be protected from liquids.

The RS Pro DPM's should be mounted in a reasonably stable ambient temperature and where the operating temperature is within the range up to 50 °C . Vibration should be kept to a minimum and the product should not be mounted where it will be subjected to excessive direct sunlight.

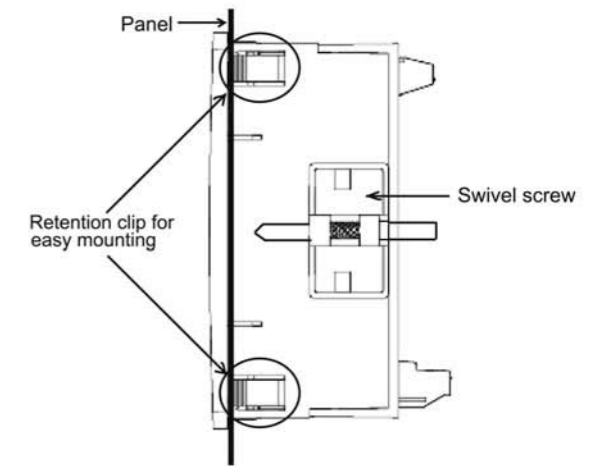

#### Caution

- In the interest of safety and functionality this product must be installed by a qualified engineer, abiding by any local regulations.
- Voltages dangerous to human life are present at some of the terminal connections of this unit. Ensure that all supplies are de-energised before attempting any connection or disconnection.
- These products do not have internal fuses therefore external fuses must be used to ensure safety under fault conditions.

#### 4.1 EMC Installation Requirements

This product has been designed to meet the certification of the EU directives when installed to a good code of practice for EMC in industrial environments, e.g.

1. Screened output and low signal input leads or have provision for fitting RF suppression components, such as ferrite absorbed . line filter! etc., in the event that RF fields cause problems.

Note: It is good practice to install sensitive electronic instruments that are performing critical functions, in EMC enclosures that protect against electrical interference which could cause a disturbance in function.

2. Avoid routing lead! alongside cables and product! that are, or could be, a source of interference.

3. To protect the product against permanent damage, surge transients must be limited to 2kV pk. It is good EMC practice to suppress differential surges to 2kV at the source. The unit has been designed to automatically recover in the event of a high level of transient!. In extreme circumstances it may be necessary to temporarily disconnect the auxiliary supply for a period of greater than 5 seconds to restore correct operation.

4. ESD precautions must be taken at all times when handling this product.

#### 4.2 Case Dimension and Panel Cut Out

##### 4.2.1 for 96X96 models

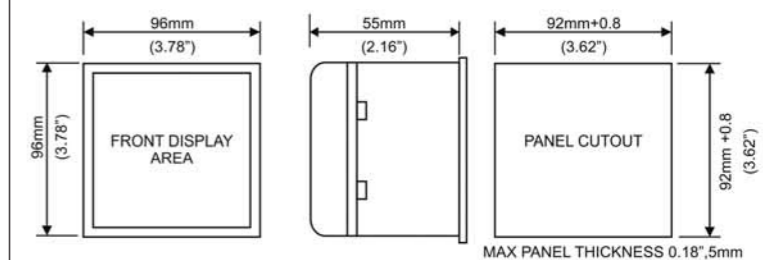

#### 4.2.1 for 48X96 models

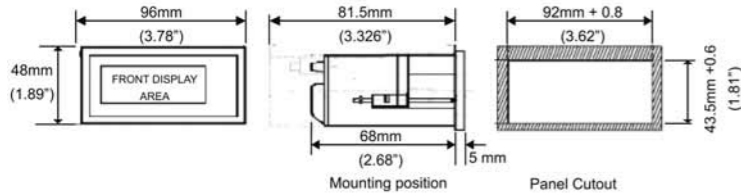

#### 4.3 Wiring

Input connections are made directly to screw-type terminals with indirect wire pressure. Numbering is clearly marked on the connector. Choice of cable should meet local regulations. Terminal for inputs will accept up to 4mm<sup>2</sup> (12 AWG) solid or 2.5mm<sup>2</sup> (12 AWG) standard cable.

Note: 1) It is recommended to use wire with lug for connection with meter.

2) For disconnecting the device a switch or circuit-breaker shall be included at the site and it shall be within easy reach of the operator.

#### 4.4 Auxiliary Supply

The RS Pro DPM's should ideally be powered from a dedicated supply, however it may be powered from the signal source, provided the source remains within the limits of the chosen auxiliary voltage.

#### 4.5 Fusing

It is recommended that all voltage lines are fitted with 1 amp HRC fuse.

#### 4.6 Earth/Ground Connections

For safety reasons, panels and accessories should be grounded in accordance with local regulations.

### 5. Connection Diagrams

#### 5.1 Connections For 136-5394 Digital AC Voltmeter 96X96 models

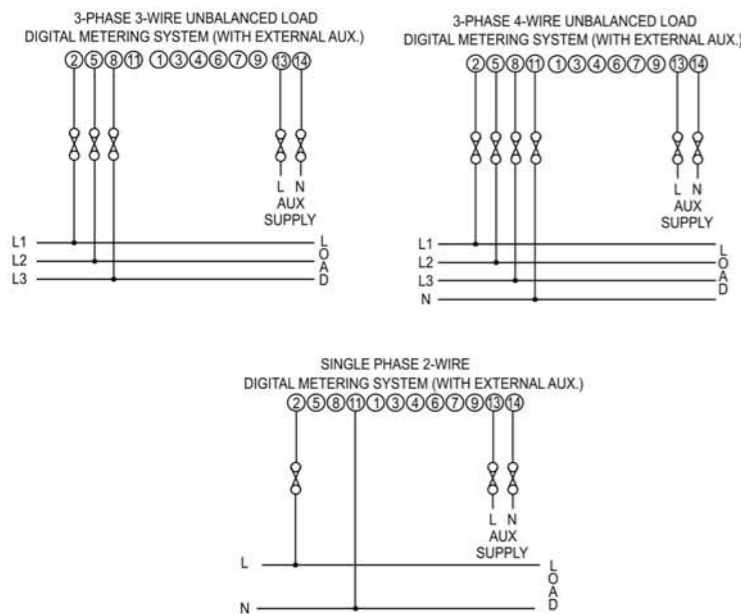

#### 5.2 Connections For 136-5391 Digital AC Ammeter 96X96 models

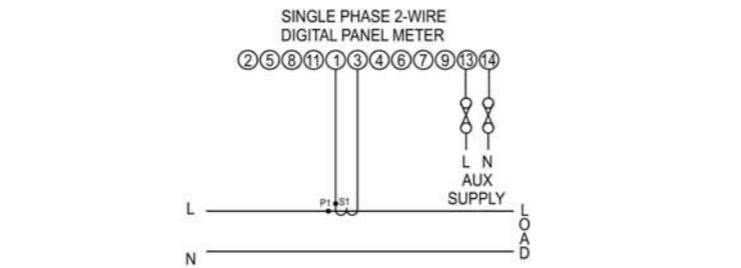
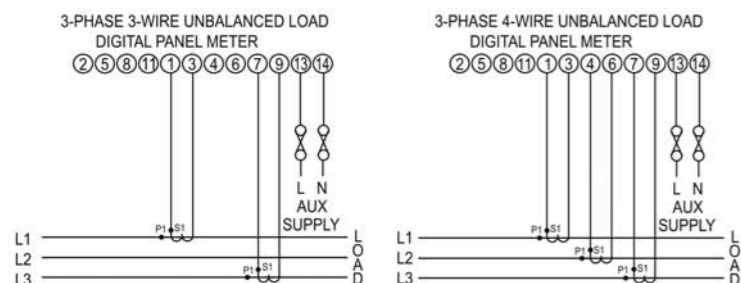

#### 5.3 Connections For 136-5393 Digital AC Voltmeter 48X96 models

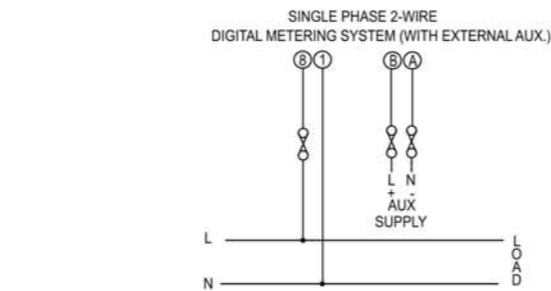
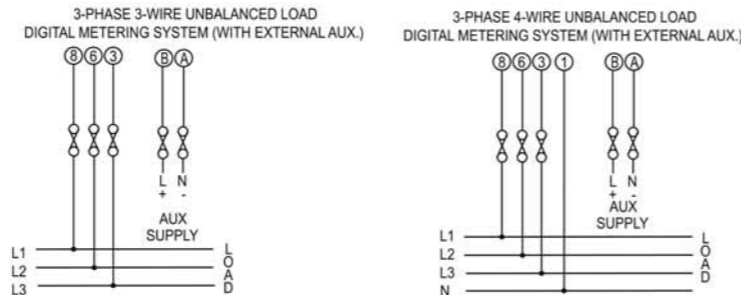

#### 5.4 Connections For 136-5390 Digital AC Ammeter 48X96 models

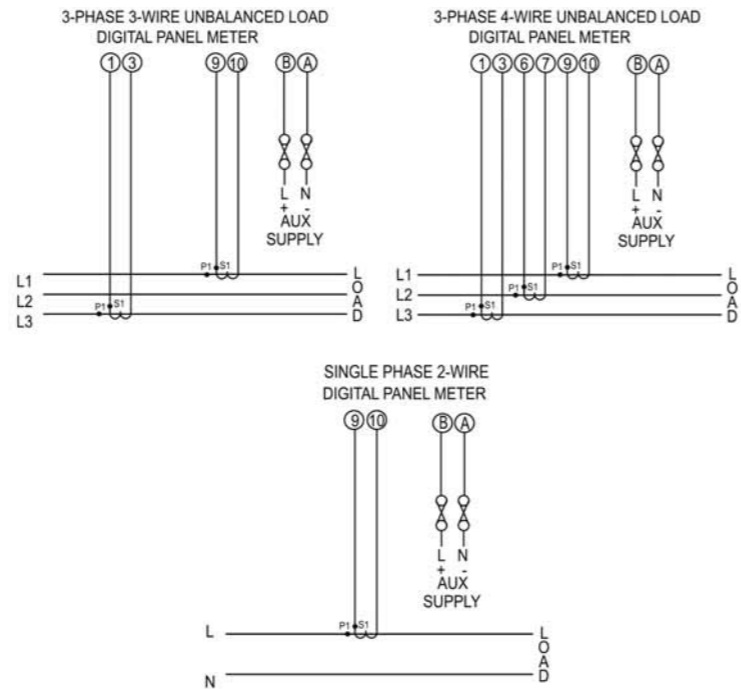

\*Note: For Measurement of parameters in :-

The DPM Digital AC Voltmeter models 136-5393 & 136-5394 the Voltage must be present between terminal 8 & 1 (Phase L1) for single phase or 3 phase 4 wire network and between terminal 6 & 8 (Phase L1-L2) or 3 & 8 (Phase L3-L1) for 3 phase 3 wire networks

The DPM Digital AC Ammeter models 136-5390 & 136-5391 the current must be present between terminal 9 & 10 (Phase I1) for 3 phase 4 wire or 3 phase 3 wire or single phase network.

### 6. Specifications

#### System

3 Phase 3 Wire/ 4 Wire or Single Phase programmable at site

#### Inputs (for Digital AC Voltmeter models 136-5393 & 136-5394) :

Nominal Input Voltage 290V<sub>L-N</sub> 500 V<sub>L-L</sub>  
 System Primary Values 100V<sub>L-L</sub> to 999 kV<sub>L-L</sub>, programmable at site  
 System Secondary Values 100V<sub>L-L</sub> to 500 V<sub>L-L</sub>, programmable at site  
 Max continuous input 120% of Rated Value

#### Voltage

Overload Indication "-oL-"  
 (If input is greater than 125% of secondary value.)  
 Max short duration input voltage 2 x Rated Value  
 Nominal input voltage burden 0.3VA approx. per phase  
 (1s application repeated 10 times at 10s intervals)

#### Inputs (for Digital AC Ammeter models 136-5390 & 136-5391) :

Nominal Input Current 5AAC  
 System CT primary values Standard Values 1 to 999 kA  
 System Secondary Values 1A / 5A, programmable at site  
 Max continuous input current 120% of Rated Value  
 Overload Indication "-oL-"  
 (If input is greater than 125% of secondary value.)

Nominal input Burden 0.2VA approx. per phase  
 Max short duration current input 20 x Rated Value (1s application repeated 5 times at 5 min. intervals)

#### Auxiliary Supply :

External Auxiliary Supply 40V to 300V AC/DC (+/- 5%)  
 Frequency Range 45 to 65 Hz  
 VA Burden 3 VA approx.

#### Operating Measuring Ranges

Digital AC Voltmeter models 136-5393 & 136-5394 : Voltage 10...120 % of Rated Value

Digital AC Ammeter models 136-5390 & 136-5391 : Current 10...120 % of Rated Value Frequency 45...65 Hz

#### Accuracy

Digital AC Voltmeter models 136-5393 & 136-5394 : Voltage 0.5 % of range+ 1 Digit (10 ..100% of Nominal Value)

Digital AC Ammeter models 136-5390 & 136-5391 : Current 0.5 % of range+ 1 Digit (10 ..100% of Nominal Value)

#### Reference conditions for Accuracy :

Reference temperature 23°C ± 2°C  
 Input frequency 50 or 60Hz + 2%  
 Input waveform Sinusoidal (distortion factor 0.005)  
 Auxiliary supply voltage Rated Value ± 1 %  
 Auxiliary supply frequency Rated Value ± 1 %

#### Nominal range of use of influence quantities for measurands

Digital AC Ammeter models 136-5390 & 136-5391 : Current 10...120 % of Rated Value

Digital AC Voltmeter models 136-5393 & 136-5394 : Voltage 10...120 % of Rated Value  
 Input frequency Rated Value ± 10 %  
 Temperature 0 to 50°C  
 Auxiliary supply voltage Rated Value ± 5 %  
 Auxiliary supply frequency Rated Value ± 10 %

#### Temperature Coefficient

Voltage (for Digital AC Voltmeter models 136-5393 & 136-5394) 0.25%/°C (10...120% of Rated Value)  
 Current (for Digital AC Ammeter models 136-5390 & 136-5391) 0.05%/°C (10...120% of Rated Value)  
 (For Rated value range of use 0... 50°C)  
 Error change due to variation of an influence quantity 2\* Error allowed for the reference condition applied in the test

#### Display

LED 1 line 4 digits  
 Digit height 20mm / 14mm optional  
 Annunciator LEDs For Displaying Units and Parameter  
 Update rate Approx. 1 seconds

#### Controls

User Interface 2 Keys

#### Isolation

Dielectric voltage withstand tests between circuits and accessible surfaces 3.3 kV RMS 50 Hz for 1 minute between all electrical circuits.

#### Standards

EMC Compatibility IEC 61326-1:2005  
 10V/m min-Level 3 industrial low level  
 Electromagnetic radiation environment IEC 61010-1 , Year 2001  
 Safety IP for water & dust IEC 60529

#### Environmental conditions

Operating temperature 0 to 50°C  
 Storage temperature -25 to +70°C  
 Relative humidity 0...90 % RH (Non condensing)  
 Warm up time 3 minute (minimum)  
 Shock 15g in 3 planes  
 Vibration ... 55 Hz, 0,15mm amplitude  
 Enclosure IP65  
 Enclosure IP  
 Material Polycarbonate Housing  
 Terminals sc,rP,i,1-tv-nP. terminals  
 96x96 models 46x46 Models  
 Bezel Size --- 48mm x 96mm  
 Depth 55mm 68mm  
 Weight 300g Approx. 250g Approx

#### Ordering Information:

##### Article No: 136-5390

RS Pro 48X96mm, 3 Phase (Single Phase), AC Ammeter 14mm display Input. 1 or 5 Amps AC, Voltage supply. 40-300V AC/DC auxiliary (Programmable CT primary and secondary values & Storage of MIN/MAX Values)

##### Article No: 136-5391

RS Pro 96X96mm, 3 Phase (Single Phase), AC Ammeter 14mm display Input. 1 or 5 Amps AC, Voltage supply. 40-300V AC/DC auxiliary (Programmable CT primary and secondary values & Storage of MIN/MAX Values)

##### Article No: 136-5393

RS Pro 48X96mm, 3 Phase (Single Phase), AC Voltmeter 14mm display Input. 100-500VLL (57.7-288V L-N), Voltage Supply. 40-300V AC/DC auxiliary (Programmable PT primary and secondary values & Storage of MIN/MAX Values)

##### Article No: 136-5394

RS Pro 96X96mm, 3 Phase (Single Phase), AC Voltmeter 14mm display Input. 100-500VLL (57.7-288V L-N), Voltage Supply. 40-300V AC/DC auxiliary (Programmable PT primary and secondary values & Storage of MIN/MAX Values)

The Information contained in these installation instructions is for use only by installers trained to make electrical power installations and is intended to describe the correct method of installation for this product. However, Company has no control over the field conditions which influence product installation. It is the user's responsibility to determine the suitability of the installation method in the user's field conditions. Company only obligations are those in Company standard Conditions of Sale for this product and in no case will Company be liable for any other incidental, indirect or consequential damages arising from the use or misuse of the products.

FOR MORE INFORMATION VISIT THIS SITE  
<http://www.rs-components.com/index.html>