

Primary switch mode power supplies CP range

Conversion table CP → CP-E, CP-S or CP-C

Dimensional drawings

Type old	Order code old	Type new / alternative	Order code new / alternative
----------	----------------	------------------------	------------------------------

Rated output voltage 5 V DC

CP-5/3.0	1SVR 423 418 R3000	CP-E 5/3.0	1SVR 427 033 R3000
----------	--------------------	------------	--------------------

Rated output voltage 6 V DC

CP-6/3.0	1SVR 423 418 R4000	not replaced	-
----------	--------------------	--------------	---

Rated output voltage 12 V DC

CP-12/2.0	1SVR 423 418 R1000	CP-E 12/2.5	1SVR 427 032 R1000
CP-12/2.0 adj	1SVR 423 418 R1100	CP-E 12/2.5	1SVR 427 032 R1000

Type old	Order code old	Type new / alternative	Order code new / alternative
----------	----------------	------------------------	------------------------------

Rated output voltage 24 V DC

CP-24/0.3	1SVR 423 418 R2000	CP-E 24/0.75	1SVR 427 030 R0000
CP-24/0.5	1SVR 423 414 R0000	CP-E 24/0.75	1SVR 427 030 R0000
CP-24/1.0	1SVR 423 418 R0000	CP-E 24/1.25	1SVR 427 031 R0000
CP-24/2.0	1SVR 423 417 R0000	CP-E 24/2.5	1SVR 427 032 R0000
CP-24/2.0	1SVR 423 417 R1000	CP-E 24/2.5	1SVR 427 032 R0000
CP-24/4.2	1SVR 423 416 R1000	CP-S 24/5.0	1SVR 427 014 R0000
CP-24/5.0	1SVR 423 416 R0000	CP-S 24/5.0	1SVR 427 015 R0100
CP-24/1.5 adj	1SVR 423 418 R5000	CP-E 24/2.5	1SVR 427 032 R0000
CP-24/2.0 adj	1SVR 423 417 R1100	CP-E 24/2.5	1SVR 427 032 R0000
CP-24/5.0 adj	1SVR 423 416 R0100	CP-C 24/5.0	1SVR 427 024 R0000
		CP-S 24/5.0	1SVR 427 014 R0000
CP-24/10 adj	1SVR 423 415 R0000	CP-C 24/10.0	1SVR 427 025 R0000
		CP-S 24/10.0	1SVR 427 015 R0100
CP-24/20 adj	1SVR 423 415 R1000	CP-C 24/20.0	1SVR 427 026 R0000
		CP-S 24/20.0	1SVR 427 016 R0100

CP-C MM

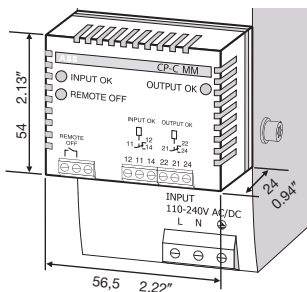

CP-A CM

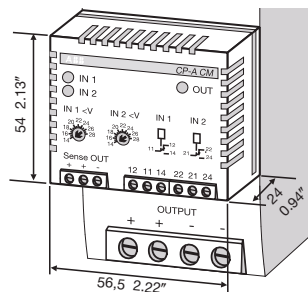

Rated output voltage 48 V DC

CP-48/0.7	1SVR 423 418 R6000	CP-E 48/1.25	1SVR 427 031 R2000
		CP-E 48/0.62	1SVR 427 030 R2000

CP-E 5/3.0, CP-E 24/0.75

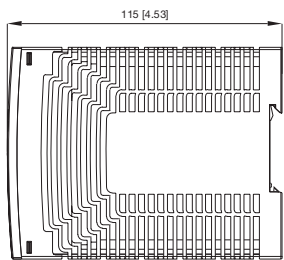
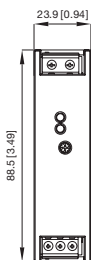

CP-E 12/2.5, CP-E 24/1.25, CP-E 24/2.5, CP-E 48/0.62, CP-E 48/1.25

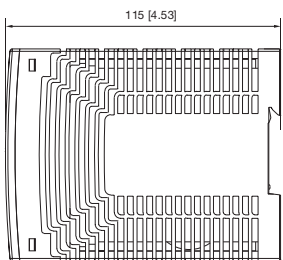
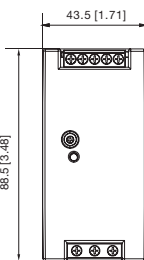

CP-RUD

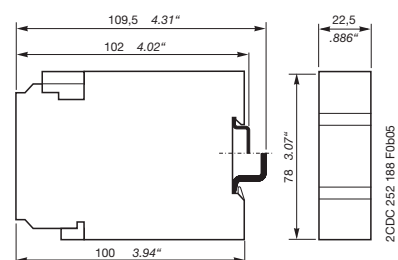

CP-S 24/5.0 CP-C 24/5.0 CP-A RU

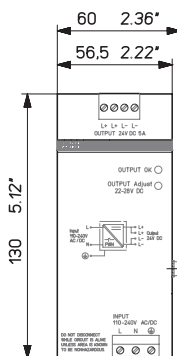
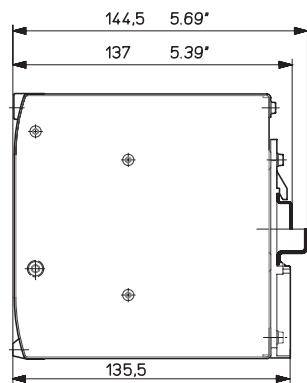

CP-S 24/10.0 CP-C 24/10.0

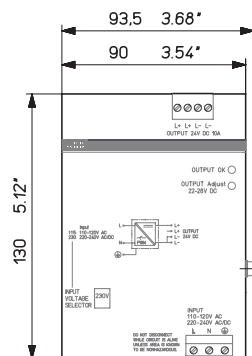

CP-S 24/20.0 CP-C 24/20.0

